

Pioneer *sound.vision.soul*

**SYSTEM CONTROL TUNER/CD
OPTICAL DIGITAL REFERENCE SYSTEM**

ENGLISH

ODR

Owner's Manual

RS-D7R

Key Finder	4
Head Unit	4
Remote Control	4
Opening and Closing the Remote Control Cover	5
● When the Cover is Closed	
● When the Cover is Open	
Remote Control and Care	7
Using the Remote Control	7
Batteries	8
Before Using This Product	9
About This Product	9
About This Manual	9
Resetting the Microprocessor	9
Precaution	10
In Case of Trouble	10
Detaching and Replacing the Front Panel	11
Theft Protection	11
● Detaching the Front Panel	
● Replacing the Front Panel	
● Warning Tone	
Setting Up the Environment for Use	13
Setting Up the Environment for Use	13
Operation at the Initial Setting Screen	13
● Accessing the Initial Setting Screen	
● Exit from the Initial Setting Screen	
Setting the Clock	15
● Switching to the Clock Adjustment Screen	
● Setting the Clock	
● Setting the Clock by Time Signal	
● Off Clock	
● Returns to the Initial Setting Screen	
Setting the Display	17
● Switching to the Display Setting Screen	
● Setting the Brightness	
● Setting the Dimmer	
● Selecting the Wallpaper	
● Selecting the Reverse Mode	
● Returns to the Initial Setting Screen	
Setting the General Environment	19
● Switching to the General Environment Setting Screen	
● Switching the AUX Mode	
● Setting the Warning Tone	
● Turning the Confirmation Sound ON/OFF	
● Setting the DAB Priority	
● Switching the Auto PI Seek	
● Changing the FM Tuning Step	
● Returns to the Initial Setting Screen	
Setting the Menu Lock	22
● About the Menu Lock	
● Switching to the Menu Lock ON/OFF	
Basic Operation	23
To Listen to Music	23
Switching Power OFF	24

Tuner Operation	25	Built-in CD Player Operation	39
Basic Operation of Tuner	25	Basic Operation of Built-in CD Player	39
Operation at the Tuner Setting Screen	26	Operation at the Built-in CD Setting Screen	41
● Accessing the Tuner Setting Screen		● Accessing the Built-in CD Setting Screen	
● Exit from the Tuner Setting Screen		● Exit from the Built-in CD Setting Screen	
Operating Each function	27	Operating Each function	42
● Best Stations Memory		● Repeat Play	
● Local Seek Tuning		● Random Play	
● Switching to the Preset Tuning Screen		● Scan Play	
● Preset Tuning		● Pause	
		● Changing the Display Mode	
		● Disc Title Input	
Using the RDS Functions	29	Multi-CD Player Operation	45
What is RDS?	29	Basic Operation of Multi-CD Player	45
Alternative Frequency function	29	Operation at the Multi-CD Setting Screen	46
● Activating/Deactivating the AF function		● Accessing the Multi-CD Setting Screen	
PI Seek function	30	● Exit from the Multi-CD Setting Screen	
● PI Seek		Operating Each function	47
● Auto PI Seek (for preset station)		● Repeat Play	
PTY function	31	● Random Play	
● Searching the PTY		● Scan Play	
● News Program Interruption Setting		● Pause	
● PTY Alarm		● Changing the Display Mode	
● Canceling Announcements		● Disc Number Search	
● PTY List		Disc Title	50
Traffic Announcement Standby function	34	● Disc Title Input	
● Activating/Deactivating the TA function		● Selecting Discs by Disc Title List	
● Canceling Traffic Announcements			
● Adjusting the TA Volume			
● TP Alarm function			
Regional function	36		
● Activating the Regional function			
Radio Text	37		
● Radio Text Display			
● Storing Radio Text in Memory			
● Recalling Preset Radio Text			

DVD Player Operation	53	Other Functions	73
Basic Operation of DVD Player	53	Using the AUX Source	73
Operation at the DVD Setting Screen	54	● Selecting the AUX Source	
● Accessing the DVD Setting Screen		● AUX Title Input	
● Exit from the DVD Setting Screen		Cellular Telephone Muting	73
Operating Each function	55	Turn OFF the Display Indication	74
● Repeat Play		CD Player and Care	75
● Random Play		CD player and care	75
● Scan Play		CD-R/CD-RW discs	75
● Pause		Built-in CD Player's Error Message	76
● Changing the Display Mode		Connecting the Units	77
● Disc Number Search		Setting Examples	78
● Disc Title Input		Power Cable Connection	79
DAB Tuner Operation	58	Attaching the Noise Filter	80
Basic Operation of DAB Tuner	58	System Connection	81
Operation at		System Example	82
the DAB Tuner Setting Screen	59	Installation	84
● Accessing the DAB Tuner Setting Screen		Installation with the rubber bush	84
● Exit from the DAB Tuner Setting Screen		Removing the unit	85
Operating Each function	60	Installing the Remote Control Unit	86
● Switching to the Preset Tuning Screen		Fitting the Remote Control Unit	86
● Preset Tuning		● Fitting horizontally	
● Announcement Support function		● Fitting vertically	
● Service Component function		Installation Using Only the Mounting Base	86
● Dynamic Label function		Installation Using the Mounting Base	
● Available PTY function		and the Bracket	87
● Service Follow function		● Method A	
TV Tuner Operation	69	● Method B	
Basic Operation of TV Tuner	69	Specifications	89
Operation at			
the TV Tuner Setting Screen	70		
● Accessing the TV Tuner Setting Screen			
● Exit from the TV Tuner Setting Screen			
Operating Each function	71		
● Best Stations Sequential Memory			
● Switching to the Preset Tuning Screen			
● Preset Tuning			

Head Unit

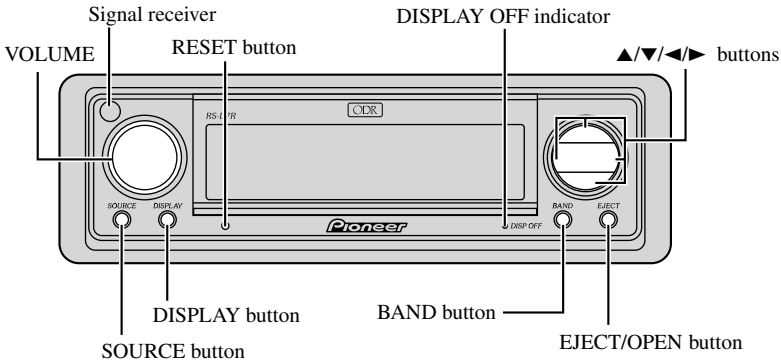

Remote Control

In this system, the available functions and the menu display vary depending on the condition of the remote controller in use. Opening the cover enables the SHIFT, RETURN and FUNCTION buttons 1–6 inside the unit. For more details, refer to the page 5.

- When operating the remote control, be sure to point it to the signal receiver on the head unit. If not, it may not operate properly.

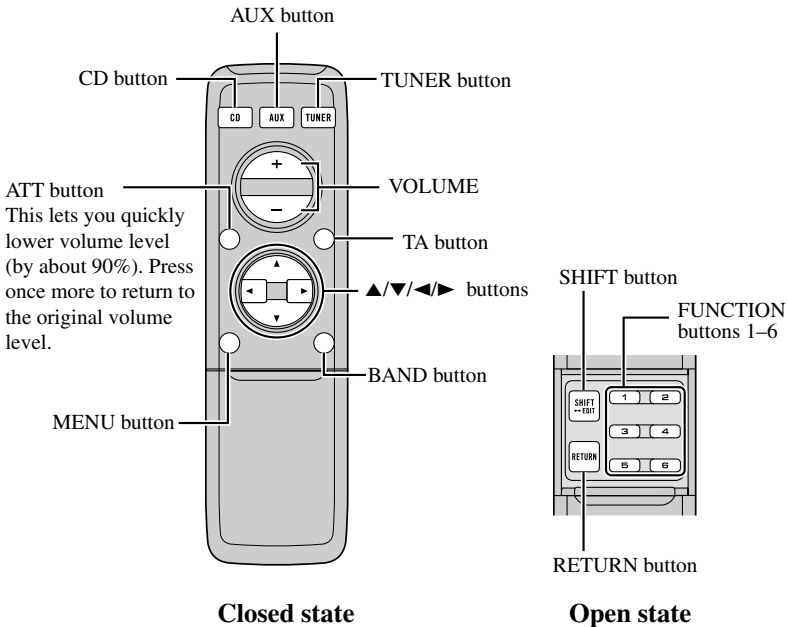

Opening and Closing the Remote Control Cover

When the remote control is opening the cover enables to operate the SHIFT, RETURN and FUNCTION buttons 1–6 inside the unit.

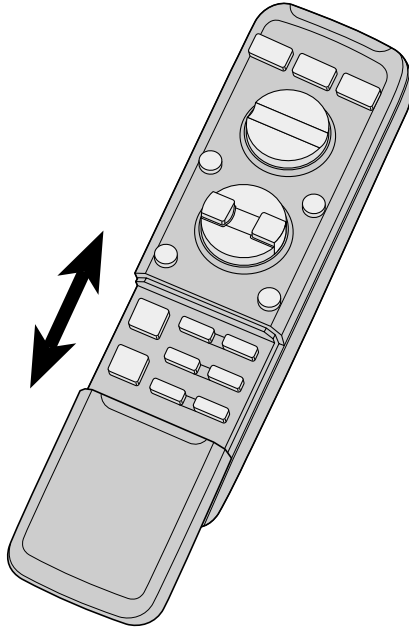

Menu displays with cover open and closed in this system, the available functions and the menu display vary depending on the condition of the remote control in use.

Remote control	Menu display
Cover closed	Closed State
Cover open	Open State

When the Cover is Closed

Closing the cover of the remote control makes the menu display to the closed state.

Menu display in closed state

Example: Built-in CD Screen

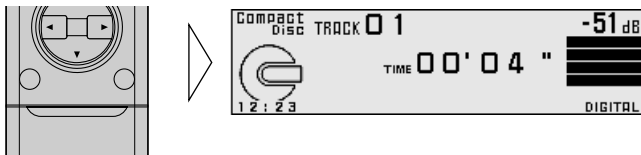

Note:

- Menu display in closed state: Current mode and functions which are ON are displayed.

When the Cover is Open

Opening the cover of the remote control makes the menu display to the open state.

Menu display in open state

Example: Built-in CD Setting Screen

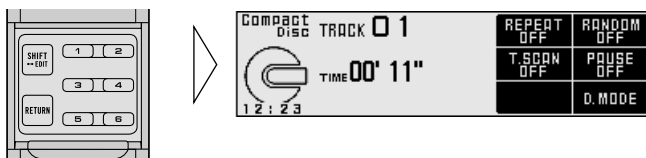

Note:

- Positions of menu items on the display correspond to the positions of FUNCTION buttons 1–6.
- Menu display in open state: Using FUNCTION buttons 1–6, operable functions are displayed.

When the cover is closed in the middle of operation

- Closing the cover during operation releases the previous operation and returns the menu display to the closed mode.

Using the Remote Control

This product is equipped with a remote control.

You can perform some operations with the head unit, however, most of operations can be conducted with the remote control.

- Point the remote control in the direction of the signal receiver to operate.
- When the remote control is not in use, attach it firmly to the provided mounting base.

Precaution:

- Do not store the remote control in high temperatures or direct sunlight.
- The remote control may not function properly in direct sunlight.
- Do not let the remote control fall onto the floor, where it may become jammed under the brake or accelerator pedal.

Batteries

- Remove the cover on the back of the remote control and insert the batteries with the (+) and (-) poles pointing in the proper direction.

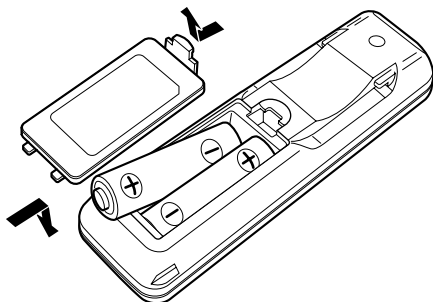

Precaution:

- Use only AAA or IEC R03 1.5 V batteries.
- Remove the batteries if the remote control is not used for a month or longer.
- Do not attempt to recharge the supplied batteries.
- Do not mix new and used batteries.
- In the event of battery leakage, wipe the remote control completely clean and install new batteries.
- When disposing of used batteries, please comply with governmental regulations or environmental public institution's rules that apply in your country/area.

Before Using This Product

About This Product

The tuner frequencies on this product are allocated for use in Western Europe, Asia, the Middle East, Africa and Oceania. Use in other areas may result in improper reception. The RDS function operates only in areas with FM stations broadcasting RDS signals.

About This Manual

This product features a number of sophisticated functions ensuring superior reception and operation. All are designed for the easiest possible use, but many are not self-explanatory. This operation manual is intended to help you benefit fully from their potential and to maximize your listening enjoyment.

We recommend that you familiarize yourself with the functions and their operation by reading through the manual before you begin using this product. It is especially important that you read and observe the “Precaution” on page 10 and in other sections.

This manual mainly explains the remote control operation. In some functions, you can perform the same operations with the head unit, however, the remote control offers a number of buttons such as ATT, TA, SHIFT, MENU, RETURN and FUNCTION buttons 1–6 which are not provided on the head unit. And most of operations can be conducted with the remote control.

Resetting the Microprocessor

The microprocessor must be reset under the following conditions:

When using this product for the first time after installation.

When the machine fails to operate properly.

When strange (incorrect) messages appear on the display.

- **To reset the microprocessor, press the RESET button on the head unit with a pen tip or other pointed instrument.**

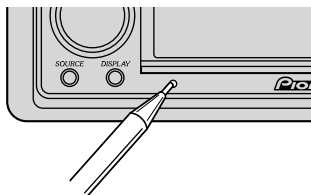

Precaution

- A “CLASS 1 LASER PRODUCT” label is affixed to the bottom of the player.



- The Pioneer CarStereo-Pass is for use only in Germany.
- Keep this manual handy as a reference for operating procedures and precautions.
- Always keep the volume low enough for outside sounds to be audible.
- Protect the product from moisture.
- If the battery is disconnected, the preset memory will be erased and must be reprogrammed.

In Case of Trouble

Should this product fail to operate properly, contact your dealer or nearest authorized Pioneer Service Station.

Detaching and Replacing the Front Panel

Theft Protection

The front panel of the head unit is detachable to discourage theft.

Precaution:

- Never use force or grip the display tightly when removing or replacing the front panel.
- Avoid subjecting the front panel to excessive shocks.
- Keep the front panel out of direct sunlight and high temperatures.

Detaching the Front Panel

1. Open the front panel.

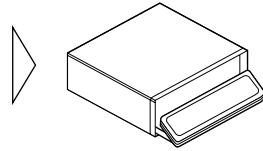

Precaution:

- A few seconds after turning the ignition switch to ON/OFF, the front panel automatically moves. When this happens, your fingers may become jammed in the panel, so keep your hands away from it.

2. Slide and remove the front panel toward you.

Take care not to grip the front panel tightly or drop it.

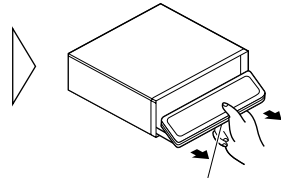

Release Section

Note:

- When removing the front panel, be sure to hold the corrugated release section on the rear of the front panel while pulling.

3. Use the protective case provided to store/carry the detached front panel.

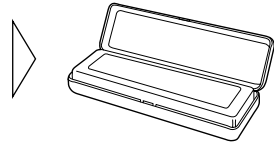

Replacing the Front Panel

1. Make sure the inner cover is closed.
2. Replace the front panel by clipping it into place.

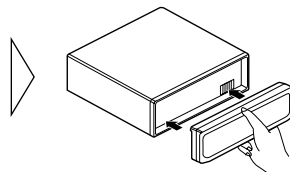

Warning Tone

If the front panel is not detached within 5 seconds after the ignition is turned off, a warning tone will sound.

Note:

- You can cancel the Warning Tone function. (Refer to page 19.)

Setting Up the Environment for Use

Choose the way to use the head unit, including adjustment of clock and selection of wallpaper. Some functions are not available unless their setting is selected. Set up the environment to suit the system to be used.

Operation at the Initial Setting Screen

Accessing the Initial Setting Screen

1. Open the cover of the remote control.
2. Press the SHIFT button.
This switches to Initial Setting Screen.
3. Select the function by pressing the FUNCTION buttons 1–4.

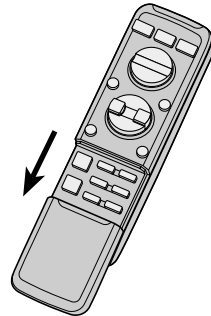

■ Initial Setting Screen

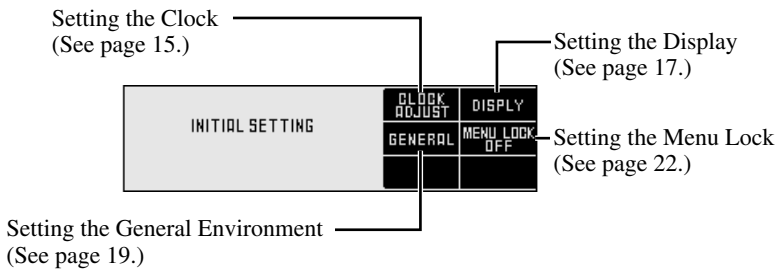

Exit from the Initial Setting Screen

- Close the cover of the remote control.

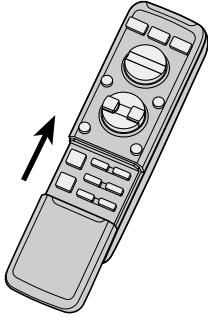

Setting the Clock

Switching to the Clock Adjustment Screen

- Press the **FUNCTION** button **1** on Initial Setting Screen.

This switches to Clock Adjustment Screen and enables clock setting.



Setting the Clock

1. Press the **◀/▶** buttons and move the cursor to the section (hour, minute) to be adjusted.



2. Press the **▲/▼** buttons to set the clock.

Holding these buttons down extends the operations continuously.

Note:

- Seconds are not displayed. However, when releasing the buttons after setting the time, the clock starts from zero second.

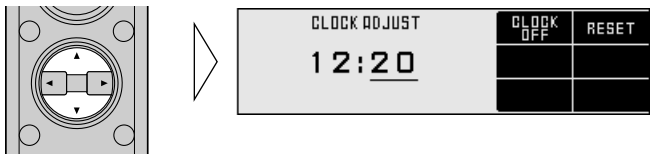

Setting the Clock by Time Signal

- Press the **FUNCTION** button 2 on Clock Adjustment Screen to reset the minute display.

As the clock starts from zero seconds when pressing the button, the clock can be set using the time signal (radio, telephone, etc).

Note:

- From 00 to 29 minutes, the hour remains the same, making the minute display “00”. From 30 to 59 minutes, it is rounded up to the next hour.



The minute display is reset to 00.

Off Clock

When the sources are OFF, the Time appears on the display.

- Press the **FUNCTION** button 1 on Clock Adjustment Screen switches the Clock Display ON/OFF.



Note:

- When the display shows the operation screen of each source, the clock time is always displayed on the screen.

Returns to the Initial Setting Screen

- Press the **RETURN** button.

The display returns to Initial Setting Screen.



Setting the Display

Switching to the Display Setting Screen

- Press the **FUNCTION button 2** on Initial Setting Screen.

This switches to Display Setting Screen and enables display setting.



Setting the Brightness

If it is hard to read the display, you can adjust the brightness for better legibility.

- Press the **◀/▶** buttons on Display Setting Screen adjusts the brightness.

The display shows “0” – “30”.



Setting the Dimmer

To enable this product’s display from being too bright at night, when the vehicle’s head lights are turned ON the display is dimmed.

You can switch this function ON/OFF.

- Press the **FUNCTION button 1** on Display Setting Screen switches the Dimmer ON/OFF.



Selecting the Wallpaper

This product is equipped with three types of wallpaper.

- Press the **FUNCTION button 2** on Display Setting Screen switches the Wallpaper.

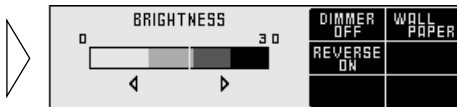

Selecting the Reverse Mode

If you do not perform an operation within about 30 seconds, screen indications start to reverse, and then continue reversing every 10 seconds. The initial setup is Reverse Mode ON.

- Press the **FUNCTION button 3** on Display Setting Screen switches the Reverse Mode ON/OFF.



Returns to the Initial Setting Screen

- Press the **RETURN button**.
The display returns to Initial Setting Screen.

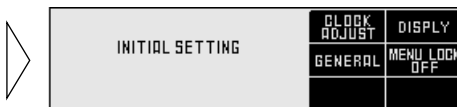

Setting the General Environment

Switching to the General Environment Setting Screen

- Press the **FUNCTION** button 3 on Initial Setting Screen.

This switches to General Environment Setting Screen and enables general environment setting.

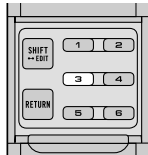

GENERAL SETTING	AUX OFF	DETACH.W OFF
	BEEP TONE ON	DAB PR ON
	AUTO PI OFF	F.STEP 100kHz

Switching the AUX Mode

It is possible to use auxiliary (AUX) equipment with this product.

Activate the AUX mode when using external equipment with this product.

- Press the **FUNCTION** button 1 on General Environment Setting Screen switches the AUX ON/OFF.



GENERAL SETTING	AUX ON	DETACH.W OFF
	BEEP TONE ON	DAB PR ON
	AUTO PI OFF	F.STEP 100kHz

Setting the Warning Tone

You can switch the Warning Tone function ON/OFF. (Refer to “Warning Tone” on page 12.)

- Press the **FUNCTION** button 2 on General Environment Setting Screen switches the Warning Tone ON/OFF.



GENERAL SETTING	AUX OFF	DETACH.W ON
	BEEP TONE ON	DAB PR ON
	AUTO PI OFF	F.STEP 100kHz

Turning the Confirmation Sound ON/OFF

The beep that sounds when buttons are pressed can be enabled or disabled (ON/OFF). The initial setting is ON.

- Press the **FUNCTION button 3** on General Environment Setting Screen switches the Confirmation Sound ON/OFF.

GENERAL SETTING	AUX OFF	DETACH.W OFF
	BEEP TONE OFF	DAB PR ON
	AUTO PI OFF	F. STEP 100kHz

Setting the DAB Priority

When a Hide-away DAB tuner (e.g. GEX-P700DAB) is connected, you can set the product in this mode so that the interruption of traffic information from the Hide-away DAB tuner takes precedence over this product's RDS Traffic Announcement (TA) function.

■ When it is ON

During DAB reception, when the selected Service Component supports Road Traffic Flashes and Transport Flashes, reception is not interrupted by this product's RDS Traffic Announcement (TA).

■ When it is OFF

Interruption is by the first received news flash from among this product's RDS and the Hide-away DAB traffic information broadcasts.

- Press the **FUNCTION button 4** on General Environment Setting Screen switches the DAB Priority ON/OFF.

GENERAL SETTING	AUX OFF	DETACH.W OFF
	BEEP TONE ON	DAB PR OFF
	AUTO PI OFF	F. STEP 100kHz

Note:

- You can only select to the DAB Priority Setting mode when a separately sold Hide-away DAB tuner (e.g. GEX-P700DAB) is connected.

Switching the Auto PI Seek

During Preset Station PI Seek operation, you can switch the Auto PI Seek function ON/OFF. (Refer to “PI Seek function” on page 30.)

- Press the **FUNCTION button 5** on General Environment Setting Screen switches the Auto PI Seek ON/OFF.



GENERAL SETTING	AUX OFF	DETACH.W OFF
	BEEP TONE ON	DAB PR ON
	AUTO PI ON	F. STEP 100kHz

Changing the FM Tuning Step

Normally set at 50 kHz during Seek tuning in the FM mode, the tuning step changes to 100 kHz when the AF or TA mode is activated.

It may be preferable to set tuning step to 50 kHz in the AF mode.

- Press the **FUNCTION button 6** on General Environment Setting Screen selects the desired tuning step.



GENERAL SETTING	AUX OFF	DETACH.W OFF
	BEEP TONE ON	DAB PR ON
	AUTO PI OFF	F. STEP 50kHz

Note:

- The tuning step remains set at 50 kHz during Manual tuning.
- The tuning step returns to 100 kHz if the battery is temporarily disconnected.

Returns to the Initial Setting Screen

- Press the **RETURN button**.
The display returns to Initial Setting Screen.



INITIAL SETTING	CLOCK ADJUST	DISPLY
	GENERAL	MENU LOCK OFF

Setting the Menu Lock

About the Menu Lock

If you switch the Menu Lock ON, it is possible to refuse the opened remote controller operation to adjust the Audio Adjustment.

It is useful when you do not want to readjust the data by mistake.

Switching to the Menu Lock ON/OFF

It is possible to switch ON/OFF the Menu Lock.

- Press the **FUNCTION** button 4 on Initial Setting Screen switches the Menu Lock ON/OFF.

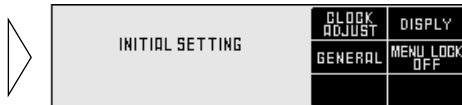

To Listen to Music

The following explains the initial of operations required before you can listen to music.

Note:

- Loading a disc in this product. (Refer to page 40.)

1. Select the desired source (e.g. tuner).

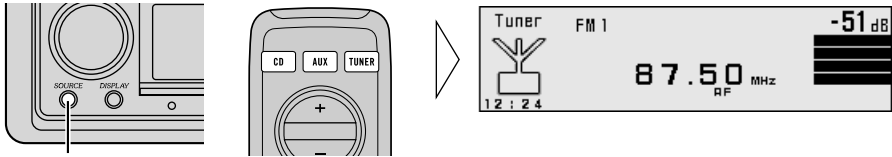

Each press changes the Source ...

■ Head Unit

Each press of the SOURCE button selects the desired source in the following order:

- Built-in CD player → Multi-CD player → DVD player → TV → Tuner
- DAB (Digital Audio Broadcasting) Tuner → External Unit 1 → External Unit 2
- AUX

■ Remote Control

Each press of the button selects the desired source in the following order:

- CD button : Built-in CD player → Multi-CD player → DVD player → OFF
- AUX button : External Unit 1 → External Unit 2 → AUX → OFF
- TUNER button : TV → Tuner → DAB (Digital Audio Broadcasting) Tuner → OFF

Note:

- External Unit refers to a Pioneer product (such as one available in the future) that, although incompatible as a source, enables control of basic functions by this product. Two External Units can be controlled by this product, although “External” is displayed whether you select External Unit 1 or External Unit 2. When two External Units are connected, the allocation of them to External Unit 1 or External Unit 2 is automatically set by this product.
- In the following cases, the sound source will not change:
 - * When a product corresponding to each source is not connected to this product.
 - * No disc is set in this product.
 - * No magazine is set in the Multi-CD player.
 - * No magazine is set in the Multi-DVD player.
 - * AUX (external input) is set to OFF. (Refer to page 19.)
- When this product's blue/white lead is connected to the car's Auto-antenna relay control terminal, the car's Auto-antenna extends when this product's source is switched ON. To retract the antenna, switch the source OFF.

2. Raise or lower the volume.

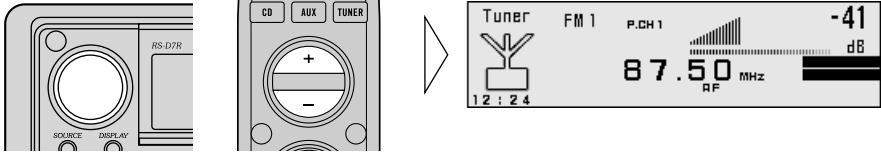

The display shows “--- dB” – “00 dB”.

Switching Power OFF

• Turn the source OFF.

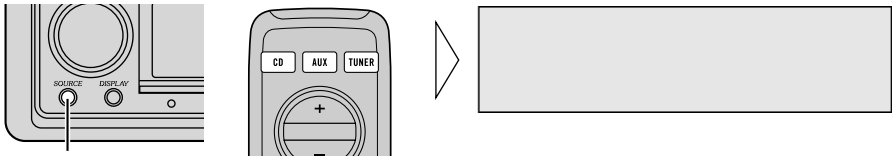

Hold for 1 second

■ Head Unit

To switch the sources OFF, hold down the SOURCE button for 1 second.

■ Remote Control

Press the button and select the source OFF.

CD button : Built-in CD player → Multi-CD player → DVD player → OFF

AUX button : External Unit 1 → External Unit 2 → AUX → OFF

TUNER button : TV → Tuner → DAB (Digital Audio Broadcasting) Tuner → OFF

Basic Operation of Tuner

This product's AF function can be switched ON and OFF. AF should be switched OFF for normal tuning operations. (Refer to page 29.)

Manual and Seek Tuning

- You can select the tuning method by changing the length of time you press the ◀/▶ button.

Manual Tuning (step by step)	0.5 seconds or less
Seek Tuning	0.5 seconds or more

Note:

- If you continue pressing the button for longer than 0.5 seconds, you can skip broadcast stations. Seek Tuning starts as soon as you release the button.
- Stereo indicator "Ⓞ" lights when a stereo station is selected.

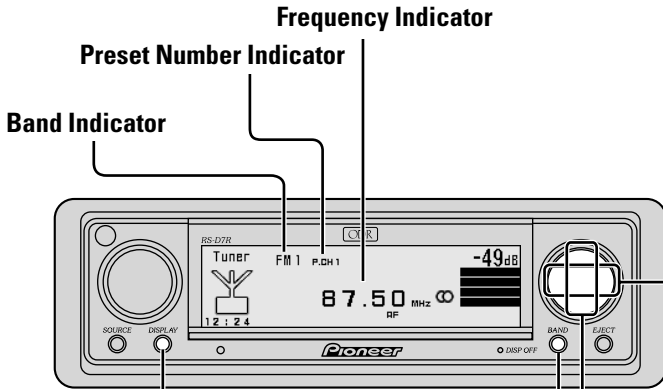

Band

FM-1 → FM-2 → FM-3 → MW/LW

Preset Tuning

You can recall memorized stations by ▲/▼ buttons.

Changing the Display

Each press of the DISPLAY button changes the display in the following order:

Program Service Name ▶ Program Service Name
 PTY Label Frequency

Operation at the Tuner Setting Screen

Accessing the Tuner Setting Screen

1. Open the cover of the remote controller.

This switches to the Tuner Setting Screen.

2. Select the function by pressing the FUNCTION buttons 1–6.

■ Tuner Setting Screen

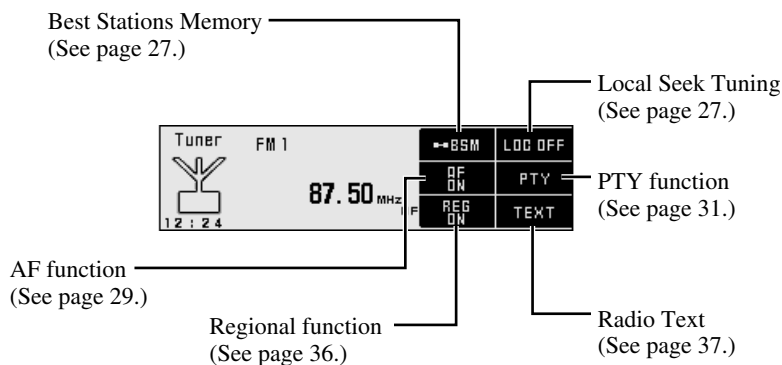

Exit from the Tuner Setting Screen

- To return to Tuner Screen, close the cover of the remote controller.

Operating Each function

Best Stations Memory

The BSM (Best Stations Memory) function stores stations in memory automatically.

- Press the **FUNCTION button 1** for two seconds on **Tuner Setting Screen** switches the **Best Stations Memory (BSM) ON**.



The stations with the strongest signals will be stored under **FUNCTION buttons 1–6** and in order of their signal strength.

- To cancel the process, press the **FUNCTION button 1** again before memorization is complete.

Local Seek Tuning

When Local mode is ON ("LOC.S" displays), you can only select broadcast stations providing strong reception.

- Press the **FUNCTION button 2** on **Tuner Setting Screen** switches the **Local sensitivity**.



The Local sensitivity switches as follows:

FM : LOC 1 → LOC 2 → LOC 3 → LOC 4 → LOC OFF

MW/LW : LOC 1 → LOC 2 → LOC OFF

Note:

- The LOC 4 setting allows reception of only the strongest stations, while lower settings let you receive progressively weaker stations.

Switching to the Preset Tuning Screen

- Press the **SHIFT** button on Tuner Setting Screen.

This switches to Preset Tuning Screen and enables to preset the stations.

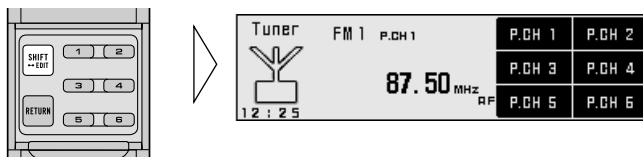

- To return to Tuner Setting Screen, press the **SHIFT** button again.

Preset Tuning

You can memorize broadcast stations in FUNCTION button 1 through 6 for easy, one-touch station recall.

■ Broadcast station preset memory

- Press the **FUNCTION** button 1 through 6 for two seconds on Preset Tuning Screen to memorize the broadcast stations in corresponding buttons.

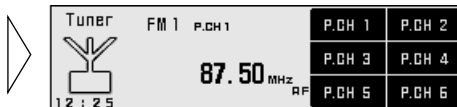

■ Preset broadcast station recall

- Press the **FUNCTION** button 1 through 6 on Preset Tuning Screen to recall the broadcast stations memorized in corresponding buttons.

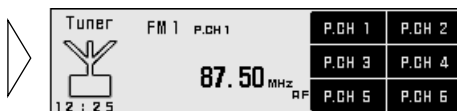

Note:

- Up to 18 FM stations (6 in FM-1, FM-2 and FM-3) and 6 MW/LW stations can be stored in memory.

What is RDS?

RDS (Radio Data System) is a system for transmitting data along with FM programs. This data, which is inaudible, provides a variety of features such as: program service name, program type display, traffic announcement standby, automatic tuning and program type tuning, intended to aid radio listeners in tuning to a desired station.

Note:

- RDS service may not be provided by all stations.
- RDS functions, like AF (Alternative Frequencies search) and TA (Traffic Announcement standby), are only active when your radio is tuned to RDS stations.

Alternative Frequency function

The AF (Alternative Frequencies search) function is used to search for other frequencies in the same network as the currently tuned station. It automatically retunes the receiver to another frequency in the network which is broadcasting a stronger signal when there are problems with reception of the currently tuned station or better reception is possible on a different frequency.

Note:

- AF tunes the receiver only to RDS stations when you use Seek tuning or BSM Auto Memory with the “AF” indicator ON.
- When you recall a preset station, the tuner may update the preset station with a new frequency from the station’s AF list. (This is only available when using presets on the FM-1 and FM-2 bands.) No preset number appears on the display if the RDS data for the station received differs from that for the originally stored station.
- Sound may be temporarily interrupted by another program during an AF frequency search.
- When the tuner is tuned to a non-RDS station, the “AF” indicator flashes.
- AF can be switched ON or OFF independently for each FM band.

Activating/Deactivating the AF function

AF is set to ON by default.

- **Press the FUNCTION button 3 on Tuner Setting Screen switches the AF ON/OFF while in an FM band .**



PI Seek function

The tuner searches for another frequency broadcasting the same programming. “PI Seek” appears on the display and the radio volume is muted during a PI Seek. The muting is discontinued after completion of the PI Seek, whether or not the PI seek has succeeded. If the PI Seek is unsuccessful, the tuner returns to the previous frequency.

PI Seek

If the tuner fails to locate a suitable alternative frequency or if the broadcasting signal is too weak for proper reception, the PI Seek will automatically start.

Auto PI Seek (for preset station)

When preset stations cannot be recalled, as when traveling long distances, the product can be set to perform PI Seek also during preset recall.

The default setting for Auto PI Seek is OFF.

Note:

- Refer to “Setting Up the Environment for Use” for details on how to switch Auto PI Seek ON/OFF.

PTY function

A PTY search is performed by program type as indicated in the PTY list (the program types are: News&Inf, Popular, Classics, Others). It also provides automatic tuning to emergency broadcasts (PTY alarm).

Note:

- There's no need to perform PTY Search settings again if they have previously been set. After switching to the PTY Search Setting mode in Step 1, just perform PTY Search in Step 3.

Searching the PTY

1. Press the **FUNCTION** button 4 on Tuner Setting Screen switches the PTY Search Setting display.



2. Select one from among PTY with the ◀/▶ buttons.

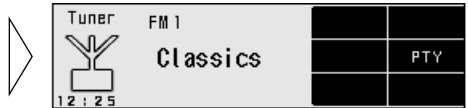

3. Press the ▲ button starts the PTY search.



The tuner searches for a station broadcasting the desired PTY.

- To cancel the PTY Search, press the ▼ button.

Note:

- The program of some stations may differ from that indicated by the transmitted PTY.
- If no station broadcasting the selected programming type is found, "NOT FOUND" is displayed for about 2 seconds, and the tuner returns to the original station.

News Program Interruption Setting

You can switch automatic reception of PTY code news programs ON/OFF. When a received news program ends, reception of the previous program resumes.

- **Set interruption to ON or OFF.**

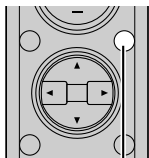

Hold for 2 seconds

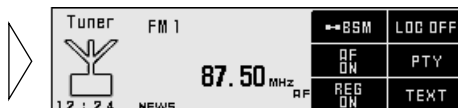

Note:

- When “N” in “NEWS” indicator is displayed, it indicates that you have set interruption ON.
- When “▶” is displayed on the left side of indicator, it indicates that the news program is received.

PTY Alarm

PTY Alarm is a special PTY code for announcements regarding emergencies such as natural disasters. When the tuner receives the radio alarm code, “ALARM” appears on the display and the volume adjusts to the TA volume. When the station stops broadcasting the emergency announcement, the system returns to the previous source.

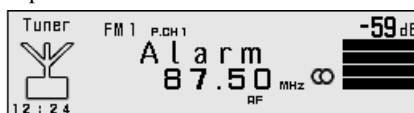

Canceling Announcements

- **Press the TA button during announcement reception to cancel the announcement and return to the previous source.**

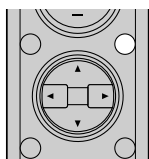

PTY List

Wide	Narrow	Details
News&Inf	News	News.
	Affairs	Current affairs.
	Info	General information and advice.
	Sport	Sports programs.
	Weather	Weather reports/Meteorological information.
	Finance	Stock market reports, commerce, trading, etc.
Popular	Pop Mus	Popular music.
	Rock Mus	Contemporary modern music.
	Easy Mus	Easy listening music.
	Oth Mus	Other types of music, which can't be categorized.
	Jazz	Jazz music based programs.
	Country	Country music based programs.
	Nat Mus	National music based programs.
	Oldies	Oldies music, 'Golden age' based programs.
	Folk Mus	Folk music based programs.
Classics	L. Class	Light classical music.
	Classic	Serious classical music.
Others	Educate	Educational programs.
	Drama	All radio plays and serials.
	Culture	Programs concerned with any aspect of national or regional culture.
	Science	Programs about nature, science and technology.
	Varied	Light entertainment programs.
	Children	Children's programs.
	Social	Social affairs programs.
	Religion	Religion affairs programs or services.
	Phone In	Phone in based programs.
	Touring	Travel programs, not for announcements about traffic problem.
	Leisure	Programs about hobbies and recreational activities.
	Document	Documentary programs.

Traffic Announcement Standby function

The TA (Traffic Announcement standby) function lets you receive traffic announcements automatically, no matter what source you are listening to. The TA function can be activated for either a TP station (a station that broadcasts traffic information) or an enhanced other network's TP station (a station carrying information which cross-references TP stations).

Activating/Deactivating the TA function

1. Tune in a TP or enhanced other network's TP station.

The TP indicator "TRAFFIC" lights when the tuner is tuned to a TP station or an enhanced other network's TP station.

2. Activate the TA function.

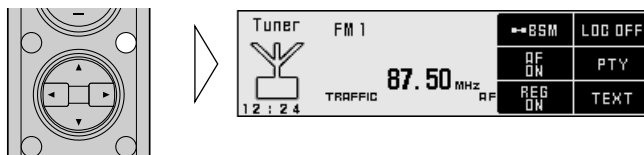

The "►TRAFFIC" indicator lights, indicating that the tuner is waiting for traffic announcements.

Note:

- If you switched TA function ON when you are tuned in to neither a TP nor enhanced other network's TP station, only "T" in "TRAFFIC" indicator is displayed.

Repeat the preceding operation when no traffic announcement is being received to deactivate the TA function.

Note:

- The system switches back to the original source following traffic announcement reception.
- The TA function can be activated from sources other than tuner if the tuner was last set to the FM band but not if it was last set to the MW/LW band.
- If the tuner was last set to FM, turning on the TA function lets you operate other tuning functions while listening to sources other than tuner.
- Only TP or enhanced other network's TP stations are tuned in during the Seek Tuning mode when the "►TRAFFIC" or "T" indicator is ON.
- Only TP or enhanced other network's TP stations are stored by BSM when the "►TRAFFIC" or "T" indicator is ON.

Canceling Traffic Announcements

- Press the TA button while a traffic announcement is being received to cancel the announcement and return to the original source.

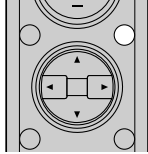

The announcement is canceled but the tuner remains in the TA mode until the TA button is pressed again.

Adjusting the TA Volume

When a traffic announcement begins, the volume adjusts automatically to a preset level to enable you to hear the announcement clearly.

- Set the volume by adjusting it during reception of a traffic announcement.

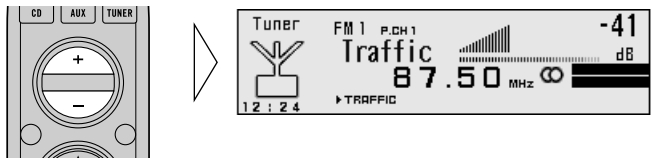

The newly set volume is stored in memory and recalled for subsequent traffic announcements.

TP Alarm function

About 30 seconds after the “▶TRAFFIC” indicator turns to “T” due to a weak signal, a 5 second beep sounds to remind you to select another TP or enhanced other network’s TP station.

- If you are listening to the tuner, tune in another TP station or enhanced other network’s TP station.

In sources other than tuner, the tuner automatically seeks out the TP station with the strongest signal in the current area 10 (or 30)* seconds after the “▶TRAFFIC” indicator turns to “T”.

* Time taken before Seek begins.

TA function ON	10 seconds
TA, AF functions ON	30 seconds

Regional function

When AF is used to retune the tuner automatically, the Regional function limits the selection to stations broadcasting regional programs.

Note:

- Regional programming and regional networks are organized differently depending on the country (i.e., they may change according to the hour, state or broadcast area).
- The preset number may disappear on the display if the tuner tunes in a regional station which differs from the originally set station.

Activating the Regional function

The Regional function can be turned ON independently for each FM band.

- **Press the FUNCTION button 5 on Tuner Setting Screen switches the Regional function ON/OFF.**

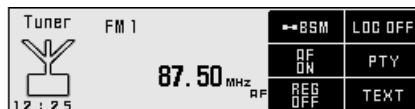

Radio Text

This tuner can display Radio Text data transmitted by RDS stations, such as station information, the name of the currently broadcast song and the name of the artist.

Note:

- When Radio Text is received, the “RT” indicator lights.
- The tuner automatically memorizes the three latest Radio Text broadcasts received, replacing text from the least recent reception with new text when it is received.
- You can store data from up to six Radio Text transmissions in FUNCTION buttons 1–6.

Radio Text Display

1. Press the **FUNCTION button 6** on Tuner Setting Screen switches the Radio Text display.



Note:

- When no Radio Text is currently being received, “NO TEXT” is displayed.

2. Recalling the three latest Radio Text broadcasts from the tuner’s memory with the **◀/▶** buttons.



Pressing the button switches between the four Radio Text data displays.

- **To return to Tuner Setting Screen, press the RETURN button.**

Note:

- If there is no Radio Text data stored in the tuner, this button does not operate.

Storing Radio Text in Memory

1. Perform “Radio Text Display” steps 1 and 2, and then select the Radio Text you want to store in memory.
2. Press the FUNCTION button 1 through 6 for two seconds to memorize the Radio Text in corresponding buttons (e.g. Press the FUNCTION button 4 for two seconds).



Recalling Preset Radio Text

1. Switch to the Radio Text display.
2. Press the FUNCTION button 1 through 6 to recall the Radio Text memorized in corresponding buttons (e.g. Press the FUNCTION button 4).



Basic Operation of Built-in CD Player

Eject

Press the EJECT/OPEN button one time, the front panel opens and then the disc is ejected.
In case of opening the front panel, you can just eject a CD.

Note:

- The CD function can be turned ON/OFF with the disc remaining in this product. (Refer to page 23.)
- A disc left partially inserted after ejection may incur damage or fall out.
- You can eject the CD by pressing and holding EJECT/OPEN button with opening the front panel when the CD loading or ejecting cannot operate properly.

Track Number Indicator

Play Time Indicator

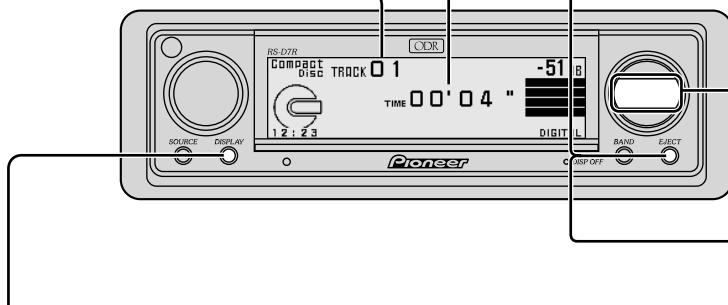

Switching the Display (only for CD TEXT Discs)

Each press of the DISPLAY button changes the display in the following order:

Play Time ▶ Play Time ▶ Play Time ▶ Play Time
Disc Title ▶ Disc Artist ▶ Track Title ▶ Track Artist

With text longer than 20 letters, you can scroll to see the rest of the text by pressing the DISPLAY button for 2 seconds.

Note:

- A CD TEXT disc is a CD featuring recorded text information such as Disc Title, Artist Name and Track Title.
- If certain text information is not recorded on a CD TEXT disc, "No ~" (e.g. "No Title") is displayed.

Track Search and Fast Forward/Reverse

- You can select between Track Search or Fast Forward/Reverse by pressing the ◀▶ button for a different length of time.

Track Search	0.5 seconds or less
Fast Forward/Reverse	Continue pressing

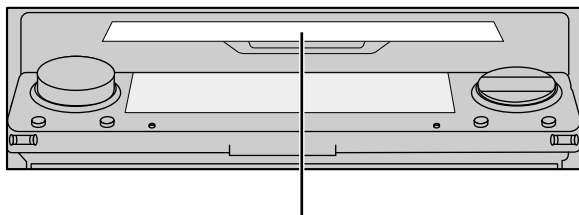

CD Loading Slot

If a CD is inserted, the front panel is closed automatically. The Built-in CD player plays one standard 12 cm or 8 cm (single) CD at a time. Do not use an adapter when playing 8 cm CD.

Note:

- If a disc cannot be inserted fully or playback fails, make sure the recorded side is down. Push the EJECT/OPEN button and check the disc for damage before reinserting it.
- If the Built-in CD player cannot operate properly, an error message (such as “ERROR-14”) appears on the display. Refer to “Built-in CD Player’s Error Message” on page 76.
- Do not insert anything other than a CD into the CD Loading Slot.

Open

Press the EJECT/OPEN button for 2 seconds, and you can open the front panel without ejecting a CD.

In case of opening the front panel, you can close it.

WARNING:

- Do not use with the front panel left open. If you do leave it open, it may result in injury in the event of an accident.

Operation at the Built-in CD Setting Screen

Accessing the Built-in CD Setting Screen

1. Open the cover of the remote controller.

This switches to the Built-in CD Setting Screen.

2. Select the function by pressing the FUNCTION buttons 1, 2, 3, 4 and 6.

■ **Built-in CD Setting Screen**

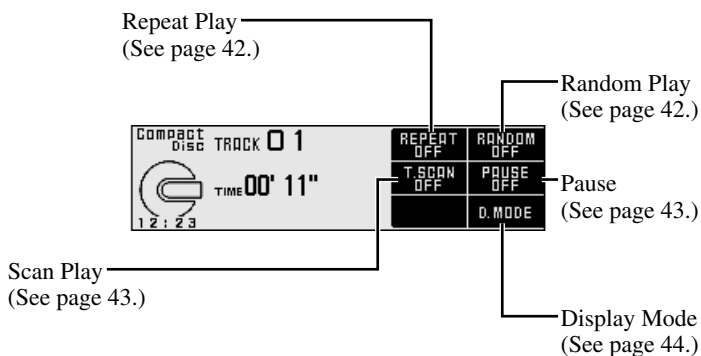

Exit from the Built-in CD Setting Screen

- To return to Built-in CD Screen, close the cover of the remote controller.

Operating Each function

Repeat Play

Repeat Play plays the same track repeatedly.

- Press the **FUNCTION** button 1 on Built-in CD Setting Screen switches the Repeat Play ON/OFF.

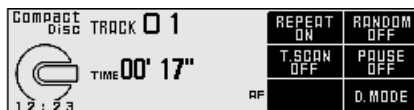

Note:

- If you perform Track Search or Fast Forward/Reverse, Repeat Play is automatically canceled.

Random Play

Random Play plays the tracks on a CD in random order for variety.

- Press the **FUNCTION** button 2 on Built-in CD Setting Screen switches the Random Play ON/OFF.

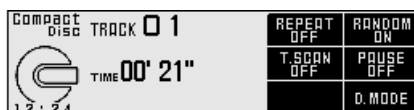

Built-in CD Player Operation

Scan Play

Scan Play plays the first 10 seconds or so of each track on a CD in succession.

1. Press the **FUNCTION** button 3 on Built-in CD Setting Screen switches the Scan Play ON.

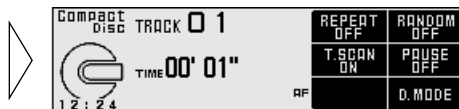

2. When you find the desired track, cancel the Scan Play with the **FUNCTION** button 3.

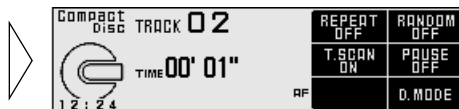

Note:

- Scan Play is canceled automatically after all the tracks on a disc have been scanned.

Pause

Pause pauses the currently playing track.

- Press the **FUNCTION** button 4 on Built-in CD Setting Screen switches the Pause ON/OFF.

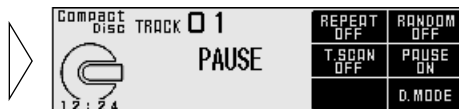

Changing the Display Mode

- Press the **FUNCTION** button 6 on Built-in CD Setting Screen switches the Display Mode in the following order:

Normal Display ↔ Simple Display

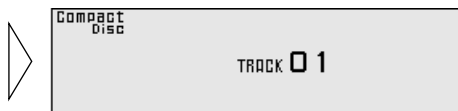

Disc Title Input

You can input up to 48 disc titles for CDs in the Built-in CD player. (Refer to “Disc Title Input” on page 50 under “Multi-CD Player Operation”.)

Note:

- After the title for 48 discs have been entered, data for a new disc will overwrite the oldest one.
- If you connect a Multi-CD player, you can input disc titles for up to 100 discs.
- When playing a CD TEXT disc on this product, you cannot switch to this mode.

Basic Operation of Multi-CD Player

This product can control a Multi-CD player (sold separately).

Track Search and Fast Forward/Reverse

- You can select between Track Search or Fast Forward/Reverse by pressing the ◀▶ button for a different length of time.

Track Search	0.5 seconds or less
Fast Forward/Reverse	Continue pressing

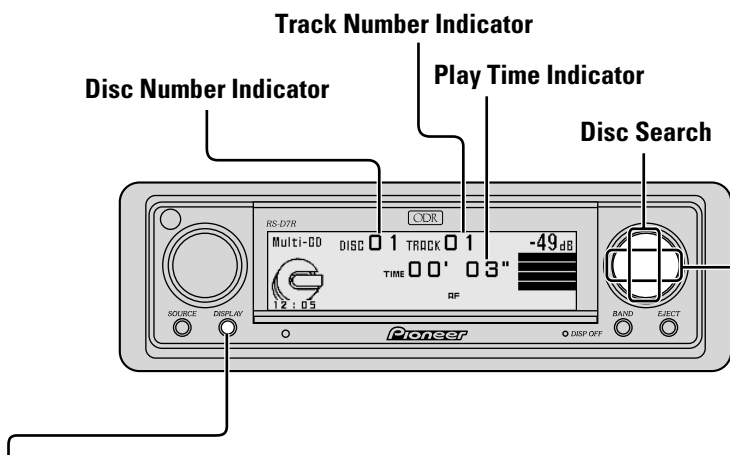

Switching the Display (When playing a CD TEXT disc on a CD TEXT compatible Multi-CD Player)

Each press of the DISPLAY button changes the display in the following order:

Play Time ▶ Play Time ▶ Play Time ▶ Play Time
Disc Title ▶ Disc Artist ▶ Track Title ▶ Track Artist

With text longer than 20 letters, you can scroll to see the rest of the text by pressing the DISPLAY button for 2 seconds.

Note:

- A CD TEXT disc is a CD featuring recorded text information such as Disc Title, Artist Name and Track Title.
- If certain text information is not recorded on a CD TEXT disc, "No ~" (e.g. "No Title") is displayed.

Operation at the Multi-CD Setting Screen

Accessing the Multi-CD Setting Screen

1. Open the cover of the remote controller.

This switches to the Multi-CD Setting Screen.

2. Select the function by pressing the FUNCTION buttons 1–6.

■ Multi-CD Setting Screen

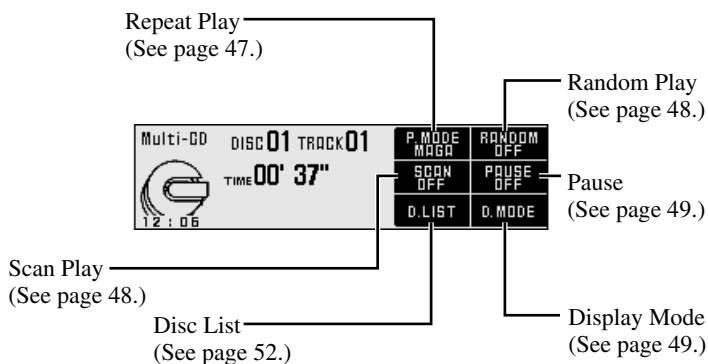

Exit from the Multi-CD Setting Screen

- To return to Multi-CD Screen, close the cover of the remote controller.

Operating Each function

Repeat Play

There are three repeat play ranges: One-track Repeat, Disc Repeat and Multi-CD player Repeat. Default repeat play range is Multi-CD player Repeat.

- Press the **FUNCTION** button 1 on Multi-CD Setting Screen switches the repeat play range as follows:



MAGA → REPEAT → D.REPEAT

■ Play Mode

Display	Play range
MAGA	Multi-CD player Repeat
REPEAT	One-Track Repeat
D.REPEAT	Disc Repeat

Note:

- If you select other discs during the repeat play, the repeat play range changes to Multi-CD player Repeat.
- If you perform Track Search or Fast Forward/Reverse during One-track Repeat, the repeat play range changes to Disc Repeat.

Random Play

Tracks are played at random within the selected repeat play range as explained in “Repeat Play” on page 47.

- **Press the FUNCTION button 2 on Multi-CD Setting Screen switches the Random Play ON/OFF.**



After selecting the desired repeat play range from those referred to in “Repeat Play” on page 47, switch Multi-CD Player Random Play ON.

Note:

- One-track Repeat changes to the Disc Repeat when you switch the Random Play ON.

Scan Play

In the Disc Repeat, the beginning of each track on the selected disc is scanned for about 10 seconds. In the Multi-CD player Repeat, the beginning of the first track on each disc is scanned for about 10 seconds.

1. **Press the FUNCTION button 3 on Multi-CD Setting Screen switches the Scan Play ON.**

After selecting the desired repeat play range from those referred to in “Repeat Play” on page 47, switch Multi-CD Player Scan Play ON.

2. **When you find the desired track (or disc), cancel the Scan Play with the FUNCTION button 3.**



Display	Play range
T. Scan	Disc Repeat
D. Scan	Multi-CD player Repeat

Note:

- Scan Play is canceled automatically after all the tracks or discs have been scanned.
- One-track Repeat changes to the Disc Repeat when you switch the Scan Play ON.

Multi-CD Player Operation

Pause

Pause pauses the currently playing track.

- Press the **FUNCTION** button 4 on Multi-CD Setting Screen switches the Pause ON/OFF.



Changing the Display Mode

- Press the **FUNCTION** button 6 on Multi-CD Setting Screen switches the Display Mode in the following order:

Normal Display ↔ Simple Display



Disc Number Search

You can select discs directly with the **FUNCTION** buttons 1–6. Just press the number corresponding to the disc you want listen to.

1. Press the **SHIFT** button on Multi-CD Setting Screen.

This switches to disc number search screen and enables select the disc.



2. Select the desired disc with the **FUNCTION** button 1 through 6.

- When a 12-Disc Multi-CD Player is connected and you want to select disc 7 to 12, press the **SHIFT** button again on the disc number search screen.

Disc Title

Disc Title Input

You can input Titles up to 20 letters long for up to 100 discs. Using this function lets you easily search for and select a desired disc for play.

Note:

- You can input Titles up to 10 letters long depending on the combined Multi-CD player.

1. Play the disc you wish to input the disc title.

2. Press the **SHIFT** button for two seconds on the Multi-CD Setting Screen.

This switches to disc title input screen.

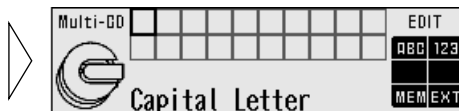

Note:

- If you press the SHIFT button for 2 seconds on disc number search screen or disc title list screen, this switches to disc title input screen.
- When playing a CD TEXT disc on a CD TEXT compatible Multi-CD player, you cannot switch to this mode.
- A CD TEXT disc is a CD featuring recorded text information such as Disc Title, Artist Name and Track Title.

3. Switch the desired character type with **FUNCTION** button 1.

Each press of FUNCTION button 1 changes the Character type in the following order:

Upper case alphabet (Capital Letter),
Numbers and Symbols → Lower case
alphabet (Small Letter) → European let-
ters (European Character), such as those
with accents (e.g. á, à, ä, ç)

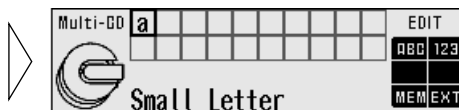

Note:

- You can select to input Numbers and Symbols by pressing FUNCTION button 2.

4. Select letters, numbers and symbols with the **▲/▼** buttons.

To insert a space, skip the box with the **▶** button.

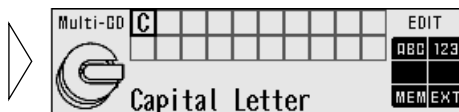

5. Move the box left and right with the **◀/▶** buttons.

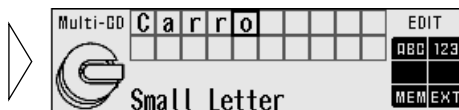

Multi-CD Player Operation

- When you have completed title input, memorize by pressing the **FUNCTION** button 5.

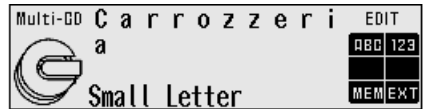

Note:

- Titles remain in memory, even after the disc has been removed from the magazine, and are recalled when the disc is reinserted.
 - After the titles for 100 discs have been entered, data for a new disc will overwrite the oldest one.
- To return to Multi-CD Setting Screen, press the **FUNCTION** button 6.

Selecting Discs by Disc Title List

Follow the procedures below to play a disc for which you have input the title in a Multi-CD player or a CD TEXT disc on a CD TEXT compatible Multi-CD player.

1. Press the **FUNCTION** button 5 on Multi-CD Setting Screen switches the disc title list screen.

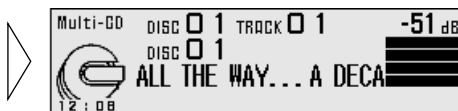

2. Select the desired disc title with the **◀/▶** buttons.

When no disc is set in the magazine (disc tray), the disc number is automatically skipped.

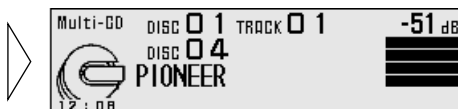

3. Play the selected disc with the **▲** button.

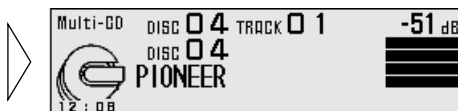

- To return to Multi-CD Setting Screen, press the **RETURN** button.

Basic Operation of DVD Player

This product can control a DVD player (sold separately).

Chapter (Track) Search and Fast Forward/Reverse

- You can select between Chapter (Track) Search or Fast Forward/Reverse by pressing the ◀▶ button for a different length of time.

Chapter (Track) Search	0.5 seconds or less
Fast Forward/Reverse	Continue pressing

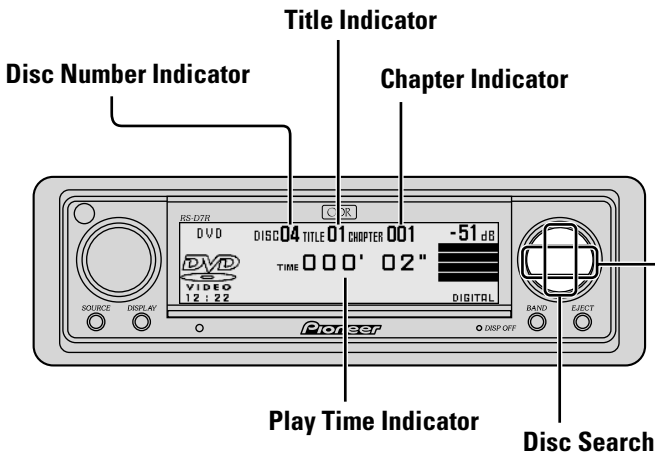

Note:

- When this product is connected to a DVD player through an optical cable, "DIGITAL" appears on the display.

Operation at the DVD Setting Screen

Accessing the DVD Setting Screen

1. Open the cover of the remote controller.

This switches to DVD Setting Screen.

2. Select the function by pressing the FUNCTION buttons 1, 2, 3, 4 and 6.

■ DVD Setting Screen

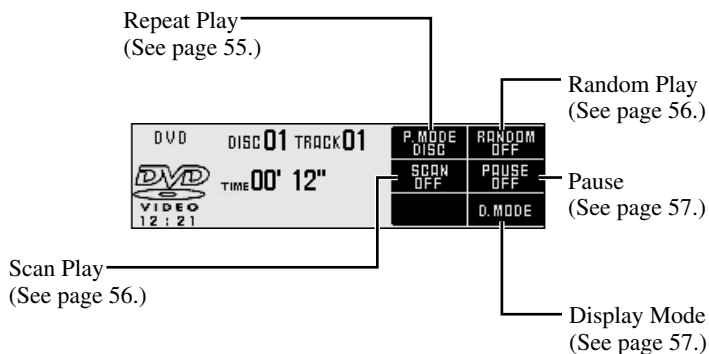

Exit from the DVD Setting Screen

- To return to DVD Screen, close the cover of the remote controller.

Operating Each function

Repeat Play

You can select the desired repeat mode play range from the chapter (track), title or disc currently in play.

- Press the **FUNCTION** button 1 on DVD Setting Screen switches the repeat play range as follows:



When DVD player is playing DVD : DISC → CHAPTER → TITLE
When DVD player is playing CDs : DISC → REPEAT

■ DVD

Display	Play range
DISC	Disc Repeat
CHAPTER	Chapter Repeat
TITLE	Title Repeat

■ Video-CD and CD

Display	Play range
DISC	Disc Repeat
REPEAT	Track Repeat

Note:

- If you select other discs during the repeat play, the repeat play range changes to Disc Repeat.
- If you perform Chapter (Track) Search or Fast Forward/Reverse during Title Repeat or Chapter Repeat, the repeat play range changes to Disc Repeat.

Random Play

Operable only when DVD Player is playing CDs.

Random Play plays the tracks on a CD in random order for variety.

- Press the **FUNCTION** button 2 on DVD Setting Screen switches the **Random Play ON/OFF**.

After selecting the desired repeat play range from those referred to in “Repeat Play” on page 55, switch DVD Player Random play ON.

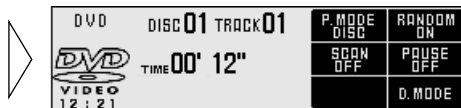

Scan Play

Operable only when DVD Player is playing CDs.

Scan Play plays the first 10 seconds or so of each track on a CD in succession.

1. Press the **FUNCTION** button 3 on DVD Setting Screen switches the **Scan Play ON**.



2. When you find the desired track, cancel the Scan Play with the **FUNCTION** button 3.

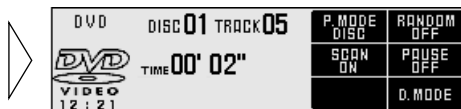

Note:

- Scan Play is canceled automatically after all the tracks on a discs have been scanned.

Pause

Pause pauses the currently playing track.

- Press the **FUNCTION** button 4 on DVD Setting Screen switches the Pause ON/OFF.

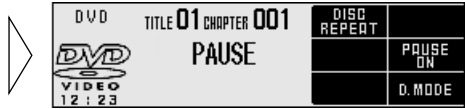

Changing the Display Mode

- Press the **FUNCTION** button 6 on DVD Setting Screen switches the Display Mode in the following order:

Normal Display ↔ Simple Display



Disc Number Search

You can select discs directly with the **FUNCTION** buttons 1–6. Just press the number corresponding to the disc you want listen to.

1. Press the **SHIFT** button on DVD Setting Screen.

This switches to disc number search screen and enables select the disc.

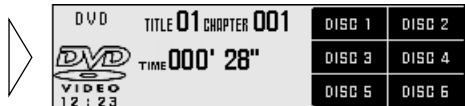

2. Select the desired disc with the **FUNCTION** button 1 through 6.

Disc Title Input

You can input up to 100 disc titles for CDs in the DVD player. (Refer to “Disc Title Input” on page 50 under “Multi-CD Player Operation”.)

Note:

- After the title for 100 discs have been entered, data for a new disc will overwrite the oldest one.
- You can input Titles up to 10 letters long.

Basic Operation of DAB Tuner

This product can control a DAB Tuner (sold separately).

Selecting the Ensemble or Service

When you first switch to DAB, Auto Seek is performed to find a DAB Ensemble.

(Auto Seek is also performed in the same way each time you switch bands.)

Once Ensemble is received, Auto Seek ends.

Select a desired Service	0.5 seconds or less
Tune to a high or low frequency (Ensemble)	0.5 seconds or more*

* By pressing the same button, search stops and the unit switches to standby for reception of that Ensemble frequency.

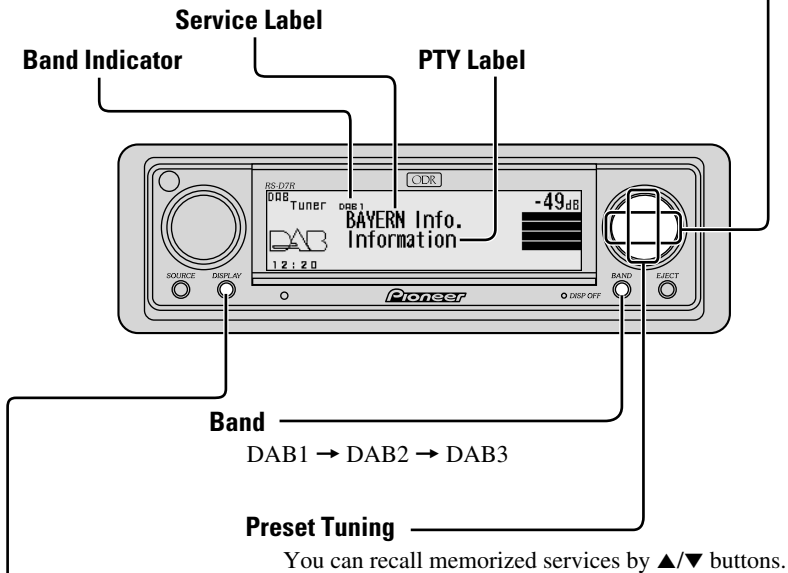

Changing the Display

Each press of the DISPLAY button changes the display in the following order:

- Service Label
- PTY Label
- Service Label
- Service Component Label
- Service Label
- Ensemble Label
- Dynamic Label

Operation at the DAB Tuner Setting Screen

Accessing the DAB Tuner Setting Screen

1. Open the cover of the remote controller.

This switches to the DAB Tuner Setting Screen.

2. Select the function by pressing the FUNCTION buttons 1–5.

■ DAB Tuner Setting Screen

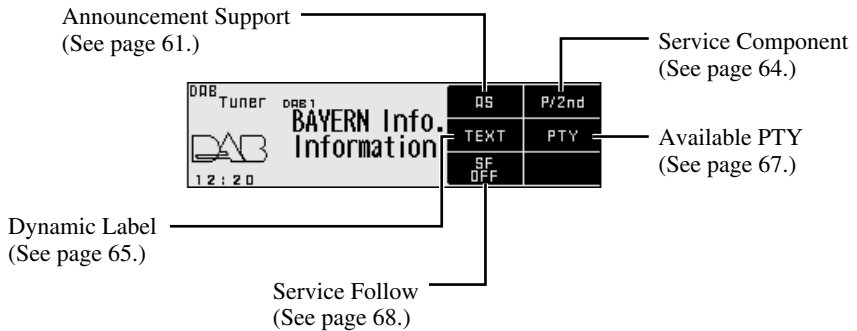

Note:

- When you connected GEX-P900DAB (II) to this product, operable functions are different. For more details, refer to GEX-P900DAB (II) operation manual.

Exit from the DAB Tuner Setting Screen

- To return to DAB Tuner Screen, close the cover of the remote controller.

Operating Each function

Switching to the Preset Tuning Screen

- Press the **SHIFT** button on **DAB Tuner Setting Screen**.

This switches to Preset Tuning Screen and enables to preset the stations.

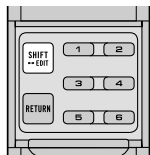

- To return to **DAB Tuner Setting Screen**, press the **SHIFT** button again.

Preset Tuning

You can memorize services in **FUNCTION** button 1 through 6 for easy, one-touch station recall.

■ Broadcast station preset memory

- Press the **FUNCTION** button 1 through 6 for two seconds on **Preset Tuning Screen** to memorize the services in corresponding buttons.



■ Preset broadcast station recall

- Press the **FUNCTION** button 1 through 6 on **Preset Tuning Screen** to recall the services memorized in corresponding buttons.



Note:

- Up to 18 services can be stored in memory.

Announcement Support function

Even when listening to non-DAB sources, the Announcement Support function lets you automatically listen to set Announcement Support. When the interrupting announcement ends, play returns to the original source.

When listening to a DAB broadcast, you can switch setting for announcement interruption ON/OFF, except for Alarm announcements. Switching between Announcements is as follows:

Announcement that is always ON:

- Alarm (Alarm)

Announcements operated by the TA button:

- Road Traffic Flash (“TRAFFIC” indicator)
- Transport Flash (“TRAFFIC” indicator)

Announcements operated with DAB Tuner Setting Screen:

- News Flash (News)
- Warning/Service (Warning)
- Special Event (Special Event)
- Sports (Sports)
- Weather Flash (Weather)
- Event Announcement (Event)
- Finance (Finance)
- Information (Information)

■ Announcements operated by the TA button

- **Press the TA button on the Remote Controller switches Road Traffic Flash and Transport Flash ON/OFF.**



Each time you press the TA button, the announcement is switched ON/OFF.

Note:

- When the Service Component supporting Road Traffic Flash and Transport Flash is selected, “▶TRAFFIC” lights.
- When the Service Component doesn't support Road Traffic Flash and Transport Flash, only “T” in “TRAFFIC” lights.
- When listening to FM, turning ON/OFF the RDS TA function will simultaneously turn ON/OFF the DAB Road Traffic Flash and Transport Flash.

- **To cancel a Road Traffic Flash or Transport Flash interruption and return to the original source, press the TA button during an Announcement interruption.**

Note:

- You can also switch in order between interrupting Announcements. (Refer to “Switching Interrupting Announcements” on page 64.)

■ TP Alarm function

When the following conditions arise, the “▶TRAFFIC” indicator turns to “T”, and after 30 seconds, the TP Alarm beeps for 10 seconds, reminding you to select a Service Component supporting Road Traffic Flash and Transport Flash.

- When Road Traffic Flash and Transport Flash interruption setting is ON.
 - When the Service Follow Function is ON.
 - When this unit (during DAB reception) cannot clearly receive a Service Component supporting Road Traffic Flash and Transport Flash.
 - When this unit RDS cannot receive a TP or enhanced other network’s TP station broadcast.
- **When listening to a DAB broadcast, after hearing the TP Alarm, you should re-tune to a Service that supports Road Traffic Flash and Transport Flash if you want to continue the possibility to receive them.**

When listening to any other sources, 30 seconds after the “▶TRAFFIC” indicator turns to “T”, search automatically starts for a Service Component in that area that supports Road Traffic Flash and Transport Flash.

■ Operating Announcements with DAB Tuner Setting Screen

1. Press the **FUNCTION button 1** on DAB Tuner Setting Screen switches the **Announcement Support setting screen.**
2. Select the announcement by pressing the **FUNCTION buttons 1–3.**

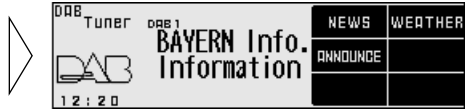

FUNCTION button 1 : “NEWS” (News) ON/OFF

FUNCTION button 2 : “WEATHER” (Weather) ON/OFF

FUNCTION button 3 : “ANNOUNCE” (Announce) ON/OFF

Note:

- When “NEWS”, “WEATHER” or “ANNOUNCE” is displayed, it indicates that Announcement Support is provided by the current Service Component.
 - When the initial of each Announcement indicator is displayed, it indicates that you have selected the Announcement Support. (e.g. “N” in “NEWS”.)
 - When “▶” is displayed on the left side of indicator, it indicates that Announcement corresponding to the Announcement Support you have selected is supported by the current Service Component.
 - When “ANNOUNCE” is ON, “Warning/Service”, “Event Announcement”, “Special Event”, “Finance”, “Sports” and “Information” are also switched ON.
- **To return to DAB Tuner Setting Screen, press the RETURN button.**

■ Switching Interrupting Announcements

When there are multiple Announcements in standby waiting to interrupt, and you are listening to an Announcement, you can switch between them in order.

- **Switch to the next Announcement.**

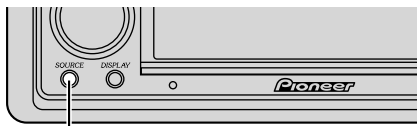

Each press changes the Announcement ...

Each time you press the SOURCE button, you move to the next Announcement. When there are no more Announcements, you return to the original one.

Service Component function

If the currently received Service has a Secondary Service Component (“EXTRA” lights), Service Component switching is possible.

- **Press the FUNCTION button 2 on DAB Tuner Setting Screen switches the Service Component.**



Dynamic Label function

Dynamic Label provides character information concerning the Service Component you're currently listening to. You can scroll the displayed information.

Note:

- When Dynamic Label is received, the "TEXT" indicator lights.
- The tuner automatically memorizes the three latest Dynamic Label received, replacing text from the least recent reception with new text when it is received.
- You can store data from up to six Dynamic Label transmissions in FUNCTION buttons 1–6.

■ Dynamic Label Display

1. Press the **FUNCTION button 3** on DAB Tuner Setting Screen switches the Dynamic Label display.



Note:

- When no Dynamic Label is currently being received, "NO TEXT" is displayed.

2. Recalling the three latest Dynamic Label broadcasts from the tuner's memory with the **◀/▶** buttons.

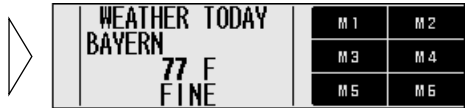

Pressing the button switches between the four Dynamic Label data displays.

Note:

- If there is no Dynamic Label data stored in the tuner, this button does not operate.

3. Scroll the Dynamic Label with the **▼** button.

Note:

- When viewing Dynamic Label, do not operate until you have parked your car safely.
- If you press the **▲** button, you return to the first line.
- If you select the Dynamic Label mode again after having canceled it, the information may switch to the latest available.
- You can also view the Dynamic Label by pressing the DISPLAY button. In this case, the headline of the data that is currently displayed is always updated. For more details, refer to "Changing the Display" on page 58.

■ Storing Dynamic Label in Memory

1. Perform “Dynamic Label Display” steps 1 and 2, and then select the Dynamic Label you want to store in memory.
2. Press the FUNCTION button 1 through 6 for two seconds to memorize the Dynamic Label in corresponding buttons (e.g. Press the FUNCTION button 4 for two seconds).



■ Recalling Preset Dynamic Label

1. Switch to the Dynamic Label display.
2. Press the FUNCTION button 1 through 6 to recall the Dynamic Label memorized in corresponding buttons (e.g. Press the FUNCTION button 4).



- To return to DAB Tuner Setting Screen, press the RETURN button.

Available PTY function

Lists of PTY that is in the Current Ensemble can be displayed. You can select the desired PTY from the list.

DAB PTY functions are slightly different from RDS PTY functions. Do not confuse DAB PTY functions and RDS PTY functions.

■ Searching the PTY

1. Press the **FUNCTION** button 4 on DAB Tuner Setting Screen switches the PTY search setting display.

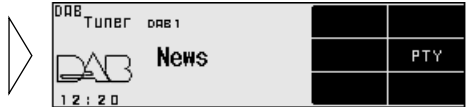

2. Select one from among PTY with the **◀/▶** buttons.

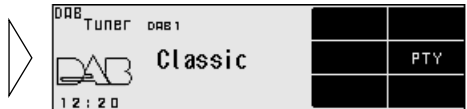

3. Press the **▲** button starts the PTY search.



DAB receives the desired PTY Service.

Note:

- The PTY method displayed is Narrow. The Wide method cannot be selected when using DAB as source. (Refer to page 33.)

■ Canceling the PTY Search Setting mode

- To cancel the PTY Search Setting mode part way through, press the **FUNCTION** button 4.

Service Follow function

If reception of the selected Service worsens, this automatically searches for other Ensemble supporting the same Service. Depending on conditions, an Ensemble supporting Alarm and Road Traffic Flash is received.

- Press the **FUNCTION** button 5 on DAB Tuner Setting Screen switches the Service Follow ON/OFF.



■ Service Follow function (FM)

When an Ensemble that supports the same Service can't be found, or when reception conditions are poor, the Service Follow function switches to an identical FM broadcast. However, switching is not possible if reception of a station broadcasting an identical FM transmission is poor, doesn't exist or is not cross-referenced by the DAB station. During FM reception, if DAB finds a Service identical to the original Service, and reception is better, DAB reception resumes. Selection is then performed in line with the Service Component selected with the first Service.

Note:

- Switch the Service Follow function ON, and the Service Follow function (FM) is automatically switched ON.
- The Service Follow function (FM) is a DAB function. If the initial source you listen to is RDS (FM), there's no switching to DAB.
- Even if you switch to an FM broadcast, the button only functions during DAB operation.

■ When the "NET" indicator flashes

When the selected Service does not have broadcast station information for an identical FM broadcast, if reception conditions for that Service worsen, the "NET" indicator flashes to indicate the Service Follow function (FM) cannot operate.

Basic Operation of TV Tuner

This product can control a TV Tuner (sold separately).

Manual and Seek Tuning

- You can select the tuning method by changing the length of time you press the ◀/▶ button.

Manual Tuning (step by step)	0.5 seconds or less
Seek Tuning	0.5 seconds or more

Note:

- If you continue pressing the button for longer than 0.5 seconds, you can skip broadcast stations. Seek Tuning starts as soon as you release the button.

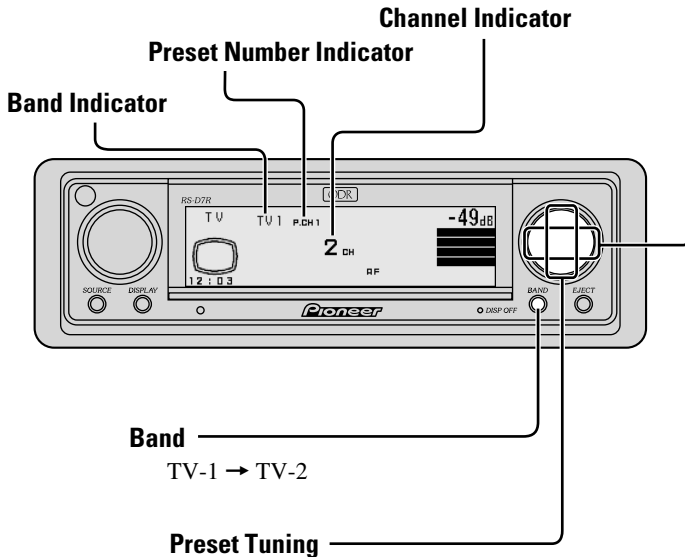

You can recall memorized stations by ▲/▼ buttons.

Operation at the TV Tuner Setting Screen

Accessing the TV Tuner Setting Screen

1. Open the cover of the remote controller.

This switches to the TV Tuner Setting Screen.

2. Select the function by pressing the FUNCTION button 1.

■ TV Tuner Setting Screen

Best Stations Sequential Memory
(See page 71.)

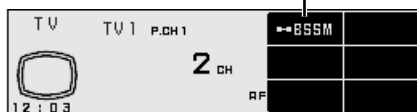

Exit from the TV Tuner Setting Screen

- To return to TV Tuner Screen, close the cover of the remote controller.

Operating Each function

Best Stations Sequential Memory

The BSSM (Best Stations Sequential Memory) function automatically memorizes strongly transmitted broadcast stations in order from the lowest channel up.

- Press the **FUNCTION** button 1 for two seconds on TV Tuner Setting Screen switches the Best Stations Sequential Memory (BSSM) ON.



- To cancel the process, press the **FUNCTION** button 1 again before memorization is complete.

Note:

- Up to 6 stations can be memorized in one Band.
- In regions where reception of less than 6 station is possible, previously memorized stations may remain in memory.

Switching to the Preset Tuning Screen

- Press the **SHIFT** button on TV Tuner Setting Screen.

This switches to Preset Tuning Screen and enables to preset the stations.

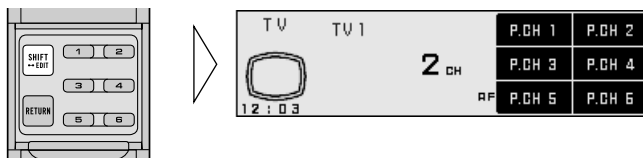

- To return to TV Tuner Setting Screen, press the **SHIFT** button again.

Preset Tuning

You can memorize broadcast stations in FUNCTION button 1 through 6 for easy, one-touch station recall.

■ Broadcast station preset memory

- Press the **FUNCTION** button 1 through 6 for two seconds on Preset Tuning Screen to memorize the broadcast stations in corresponding buttons.

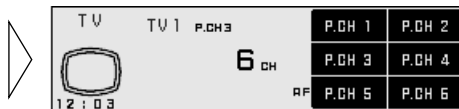

■ Preset broadcast station recall

- Press the **FUNCTION** button 1 through 6 on Preset Tuning Screen to recall the broadcast stations memorized in corresponding buttons.

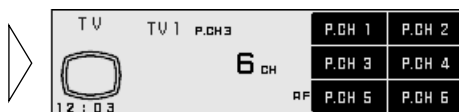

Note:

- Up to 12 stations (6 in TV1 and TV2) can be stored in memory.

Using the AUX Source

An IP-BUS-RCA Interconnector such as CD-RB20 or CD-RB10 (sold separately) enables you to connect this product to auxiliary equipment featuring an RCA output. For more details, refer to the IP-BUS-RCA Interconnector's Owner's Manual.

Selecting the AUX Source

- **Select AUX. (Refer to page 23.)**

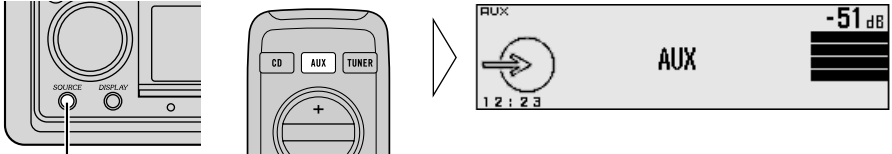

Each press changes the Source ...

AUX Title Input

The display title for AUX Source can be changed.

1. **Open the cover of the remote controller.**

This switches to AUX setting screen.

2. **Press the SHIFT button for two seconds on the AUX setting screen.**



3. **Input the AUX Title.**

Refer to "Disc Title Input" on page 50, and perform procedures 3 to 6 in the same way.

Cellular Telephone Muting

Sound from this system is muted automatically when a call is made or received using a cellular telephone connected to this product.

- The sound is turned off, "MUTE" is displayed and no audio adjustment is possible. Operation returns to normal when the phone connection is ended.

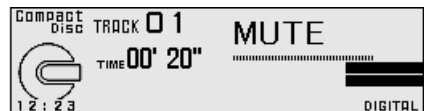

Turn OFF the Display Indication

You can turn off the display indication. If you press any button while the display indication is off, it will light up for 5 seconds and then turn off again.

- Press the **BAND** button for two seconds switches the display indication **ON/OFF**.

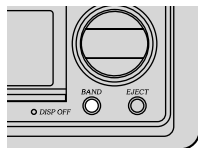

Note:

- While the display indication is turning off, DISPLAY OFF indicator lights up (refer to page 4).

CD player and care

- Use only CDs that have either of the two Compact Disc Digital Audio marks as shown below.



- Use only normal, round CDs. If you insert irregular, non-round, shaped CDs they may jam in the CD player or not play properly.

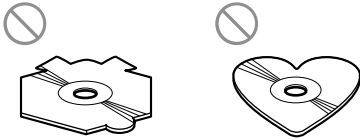

- Check all CDs for cracks, scratches or warping before playing. CDs that have cracks, scratches or are warped may not play properly. Do not use such discs.
- Avoid touching the recorded (non-printed) surface when handling the disc.
- Store discs in their cases when not in use.
- Keep discs out of direct sunlight and do not expose the discs to high temperatures.
- Do not attach labels, write on or apply chemicals to the surface of the discs.
- To clean a CD, wipe the disc with a soft cloth outward from the center.

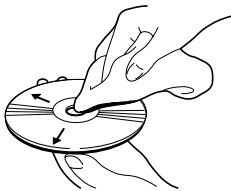

- If the heater is used in cold weather, moisture may form on components inside the CD player. Condensation may cause the CD player to malfunction. If you think that condensation is a problem turn off the CD player for an hour or so to allow it to dry out and wipe any damp discs with a soft cloth to remove the moisture.
- Road shocks may interrupt CD playback.

CD-R/CD-RW discs

- When CD-R/CD-RW discs are used, playback is possible only for discs which have been finalized.
- It may not be possible to play back CD-R/CD-RW discs recorded on a music CD recorder or a personal computer because of disc characteristics, scratches or dirt on the disc, or dirt, condensation, etc., on the lens of this unit.
- Playback of discs recorded on a personal computer may not be possible, depending on the application settings and the environment. Please record with the correct format. (For details, contact the manufacturer of the application.)
- Playback of CD-R/CD-RW discs may become impossible in case of direct exposure to sunlight, high temperatures, or the storage conditions in the car.
- Titles and other text information recorded on a CD-R/CD-RW disc may not be displayed by this unit.
- This unit conforms to the track skip function of the CD-R/CD-RW disc. The tracks containing the track skip information are skipped automatically.
- If you insert a CD-RW disc into this unit, time to playback will be longer than when you insert a conventional CD or CD-R disc.
- Read the precautions with CD-R/CD-RW discs before using them.

Built-in CD Player's Error Message

When problems occur with CD playback, an error message appears on the display. Refer to the table below to identify the problem, then take the suggested corrective action. If the error persists, contact your dealer or your nearest PIONEER Service Center.

Message	Possible cause	Recommended action
ERROR- 11, 12, 17, 30	Dirty disc.	Clean the disc.
ERROR- 11, 12, 17, 30	Scratched disc.	Replace the disc.
ERROR- 14	Unrecorded CD.	Check the disc.
ERROR- 10, 11, 12, 14, 17, 30, A0	Electrical or mechanical problem.	Turn the ignition ON and OFF, or switch to a different source, then back to the CD player.
ERROR- 44	All tracks are setting track skip.	Replace the disc.
HEAT	CD player overheating.	Discontinue play until the machine temperature drops.

Connecting the Units

Note:

- This unit is for vehicles with a 12-volt battery and negative grounding. Before installing it in a recreational vehicle, truck, or bus, check the battery voltage.
- To avoid shorts in the electrical system, be sure to disconnect the \ominus battery cable before beginning installation.
- Refer to the owner's manual for details on connecting the power amp and other units, then make connections correctly.
- Secure the wiring with cable clamps or adhesive tape. To protect the wiring, wrap adhesive tape around them where they lie against metal parts.
- Route and secure all wiring so it cannot touch any moving parts, such as the gear shift, handbrake, and seat rails. Do not route wiring in places that get hot, such as near the heater outlet. If the insulation of the wiring melts or gets torn, there is a danger of the wiring short-circuiting to the vehicle body.
- Don't pass the yellow lead through a hole into the engine compartment to connect to the battery. This will damage the lead insulation and cause a very dangerous short.
- Do not shorten any leads. If you do, the protection circuit may fail to work when it should.
- Never feed power to other equipment by cutting the insulation of the power supply lead of the unit and tapping into the lead. The current capacity of the lead will be exceeded, causing overheating.
- When replacing a fuse, be sure to use only fuses of the rating prescribed on the fuse holder.
- The black lead is ground. Please ground this lead separately from the ground of high-current products such as power amps.
- If you ground the products together and the ground becomes detached, there is a risk of damage to the products or fire.
- When this product's source is switched ON, a control signal is output through the blue/white lead. Connect to an external power amp's system remote control or the car's Auto-antenna relay control terminal (max. 300 mA 12 V DC). If the car features a glass antenna, connect to the antenna booster power supply terminal.

- When an external power amp is being used with this system, be sure not to connect the blue/white lead to the amp's power terminal. Likewise, do not connect the blue/white lead to the power terminal of the auto-antenna. Such connection could cause excessive current drain and malfunction.
- To avoid short-circuiting, cover the disconnected lead with insulating tape. There is a possibility of short-circuiting if the leads are not insulated.
- To prevent incorrect connection, the input side of the IP-BUS connector and Optical connector is blue, and the output side is black. Connect the connectors of the same colors correctly.
- Connection of this system requires optical cables and IP-BUS cables. Consult your nearest dealer for more detail.
- Set GPS antenna away from this unit. If you set them too close, it may fail to operate properly.
- **This unit can not be installed in a vehicle that does not have an ACC (accessory) position on the ignition switch. (Fig. 1)**

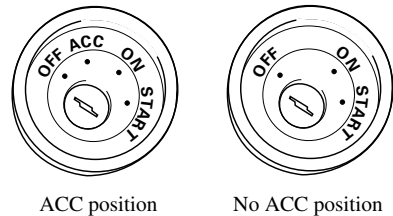

Fig. 1

- Cords for this product and those for other products may be different colors even if they have the same function. When connecting this product to another product, refer to the supplied Installation manuals of both products and connect cords that have the same function.

Setting Examples

System Example with Multi-CD Player

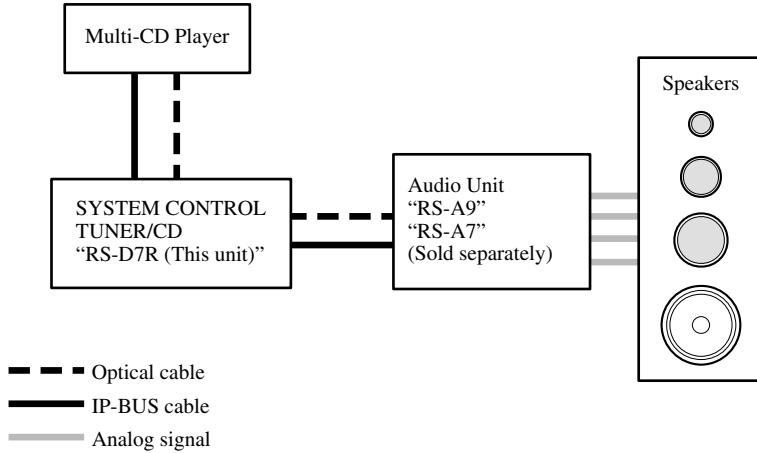

Fig. 2

System Example with DVD Player

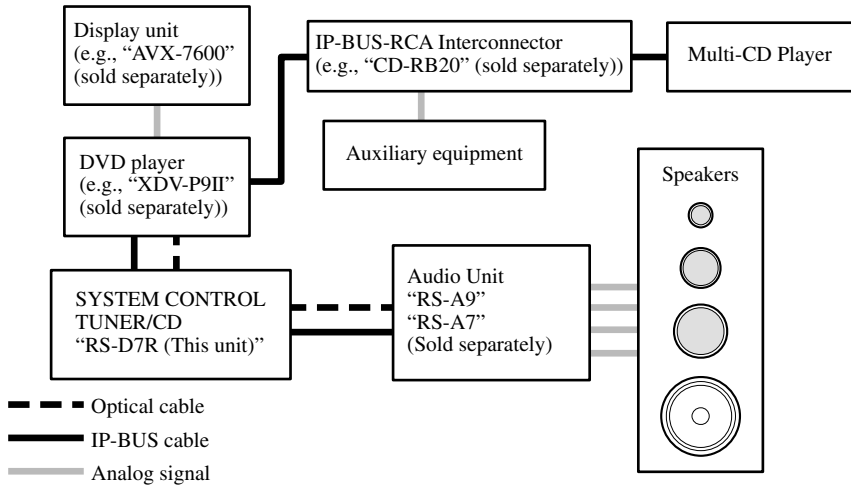

Fig. 3

Power Cable Connection

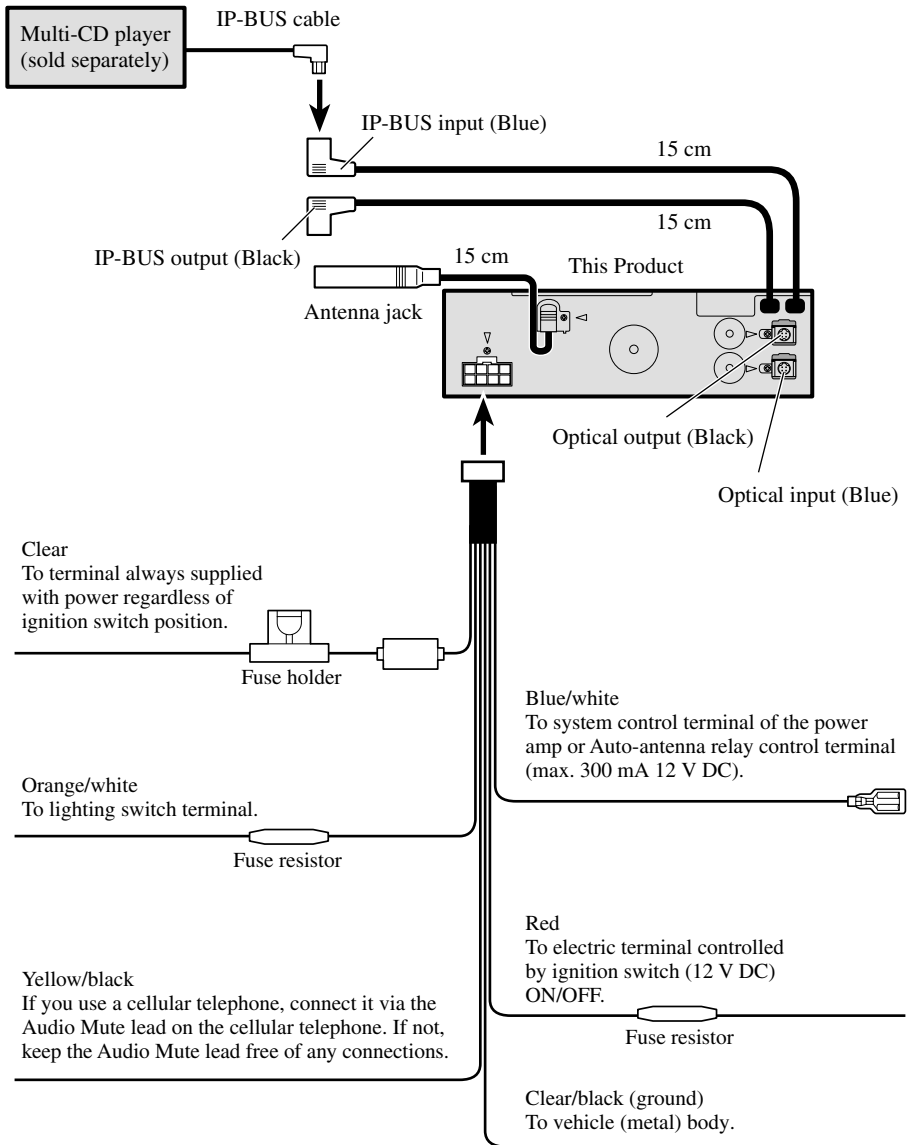

Fig. 4

Attaching the Noise Filter

To prevent the noise, use the supplied noise filter correctly.

1. Attach the supplied noise filter to each of the groups of cables as shown below.

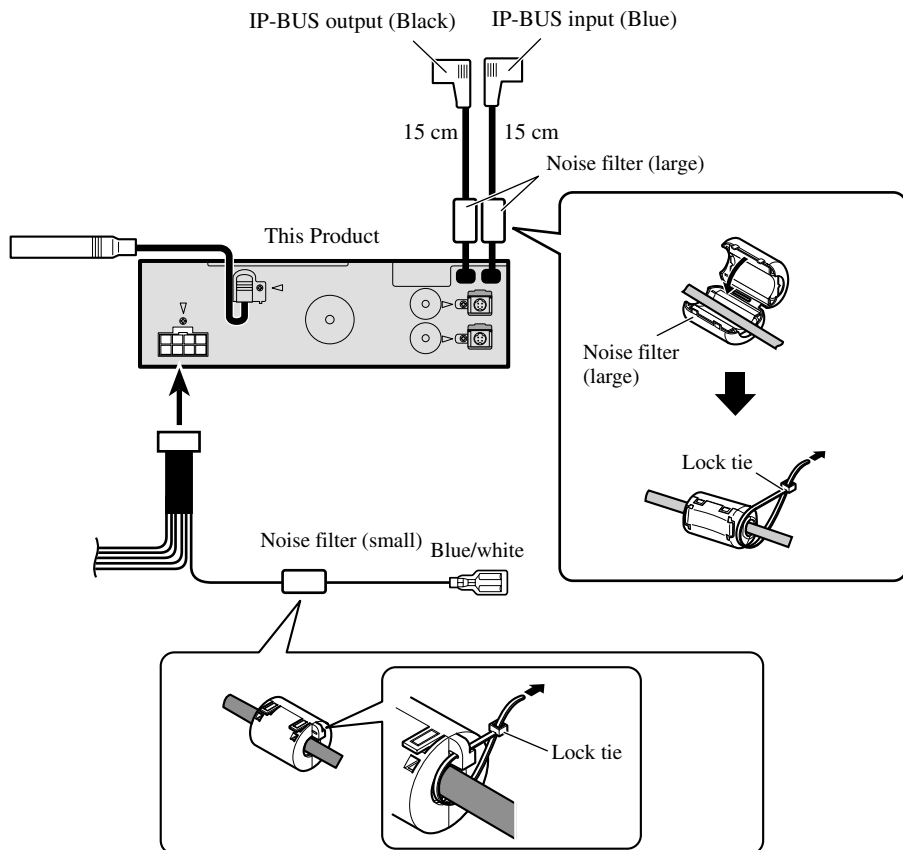

Fig. 5

Connecting the Units

System Connection

*1 IP-BUS cable

*2 Optical cable

*3 RCA cable (sold separately)

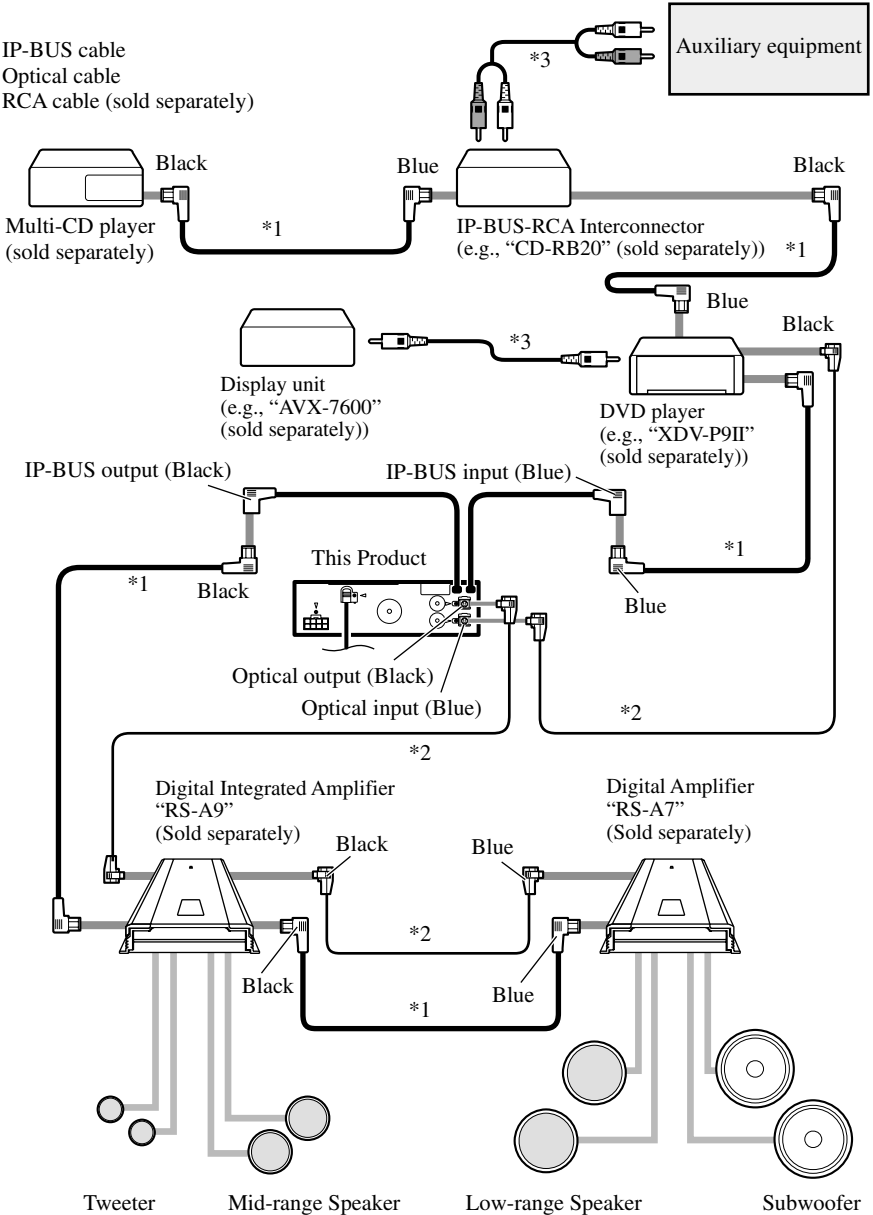

System Example

System with a Digital Integrated Amplifier "RS-A9"

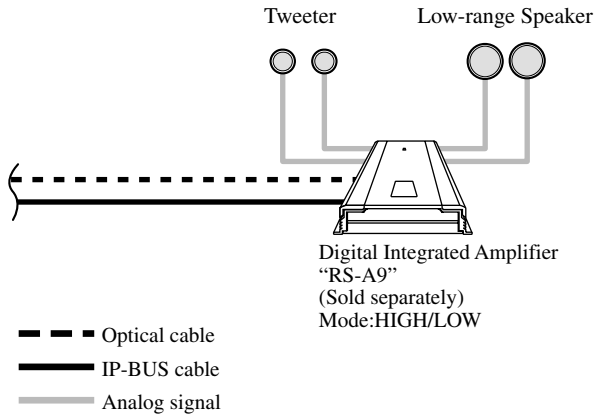

Fig. 7

System with a Digital Integrated Amplifier "RS-A9" and a Digital Amplifier "RS-A7"

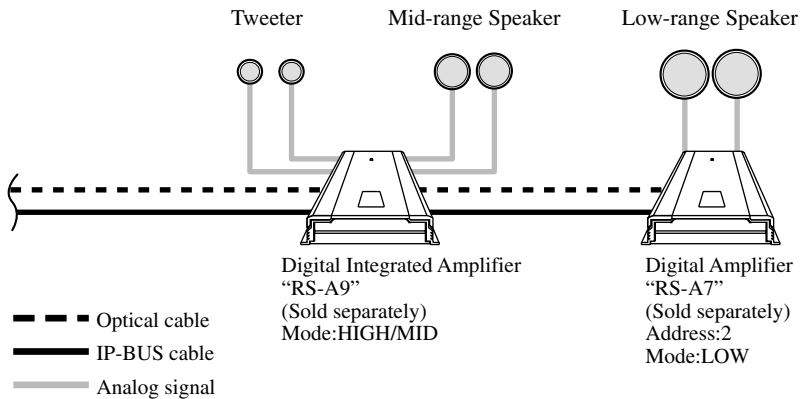

Fig. 8

System with a Digital Integrated Amplifier "RS-A9" and a Digital Amplifier "RS-A7"

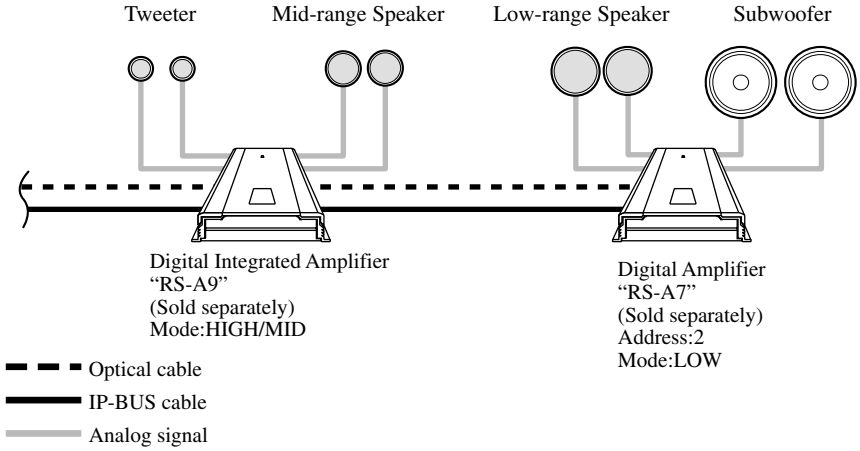

Fig. 9

System with a Digital Integrated Amplifier "RS-A9" and Three Digital Amplifiers "RS-A7"

—Full Balanced Pure Digital System—

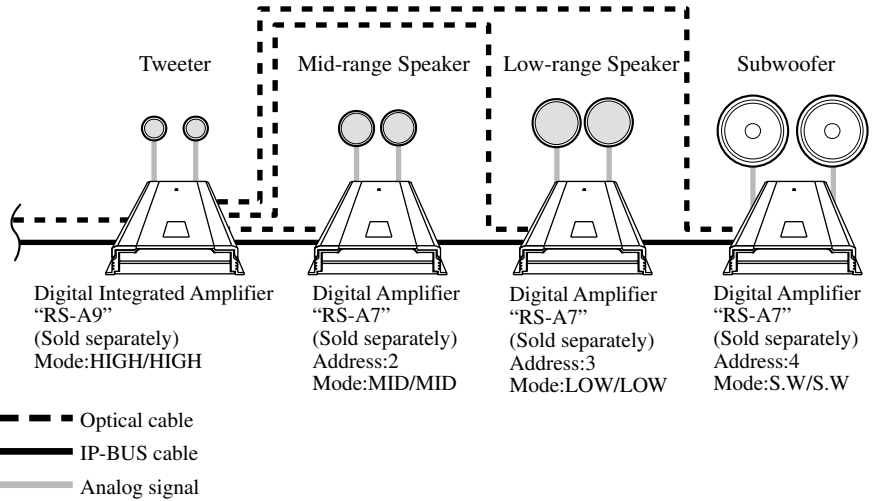

Fig. 10

Note:

- Before finally installing the unit, connect the wiring temporarily, making sure it is all connected up properly, and the unit and the system work properly.
 - Use only the parts included with the unit to ensure proper installation. The use of unauthorized parts can cause malfunction.
 - Consult with your nearest dealer if installation requires the drilling of holes or other modifications of the vehicle.
 - Install the unit where it does not get in the driver's way and cannot injure the passenger if there is a sudden stop, like an emergency stop.
 - The semiconductor laser will be damaged if it overheats, so don't install the unit anywhere hot — for instance, near a heater outlet.
- If installation angle exceeds 60° from horizontal, the unit might not give its optimum performance. (Fig. 11)

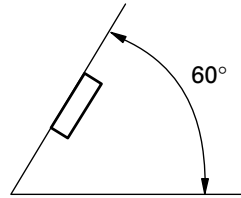
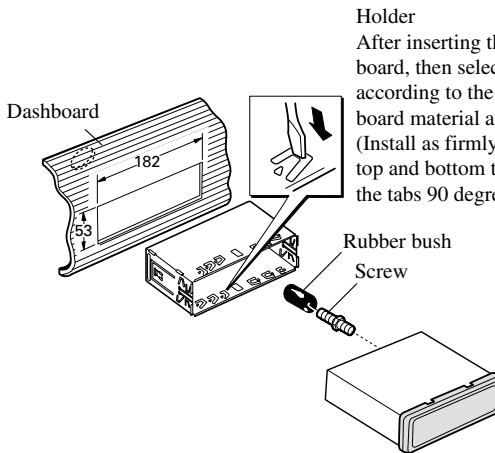

Fig. 11

Installation with the rubber bush



Holder

After inserting the holder into the dashboard, then select the appropriate tabs according to the thickness of the dashboard material and bend them. (Install as firmly as possible using the top and bottom tabs. To secure, bend the tabs 90 degrees.)

Fig. 12

Removing the Unit

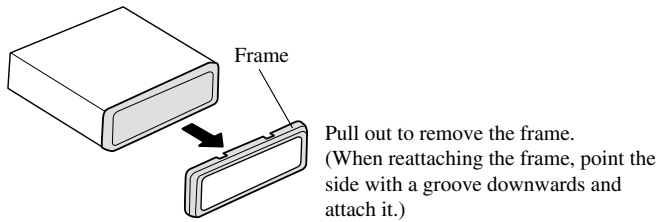

Fig. 13

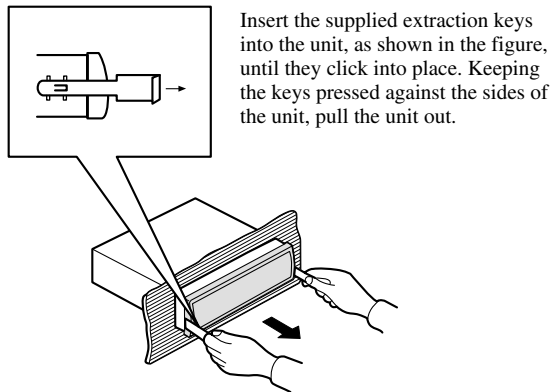

Fig. 14

Fitting the Remote Control Unit

Precaution:

- Press the remote controller unit onto the mounting base until it clicks into place.

Fitting horizontally

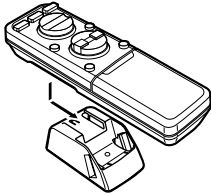

Fig. 15

Fitting vertically

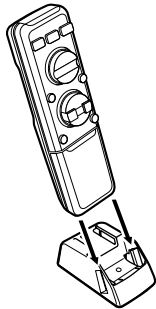

Fig. 16

Note:

- If the remote controller is installed vertically, you can not open the remote controller cover.

Installation Using Only the Mounting Base

Precaution:

- To avoid it being a hindrance to driving, always install the remote control unit to the passenger's side — not the driver's side.
- Before using double-sided tape, clean off any dirt on the surface to which the double-sided tape is to be attached.

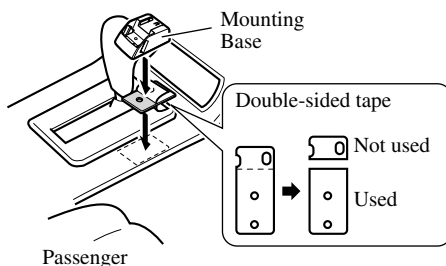

Fig. 17

Installing the Remote Control Unit

Installation Using the Mounting Base and the Bracket

Precaution:

- To avoid it being a hindrance to driving, always install the remote control unit to the passenger's side – not the driver's side.
- Install the mounting base so that the remote control unit is slanting upwards at an angle when fitted.
- Before using double-sided tape, clean off any dirt on the surface to which the double-sided tape is to be attached.
- Before drilling any mounting holes, confirm that the screws will not interfere with any of the cars operating systems (such as the fuel line, brake lines, electrical wiring, etc.).

Method A

This example is for when the console is wide enough to have installation space for the mounting base.

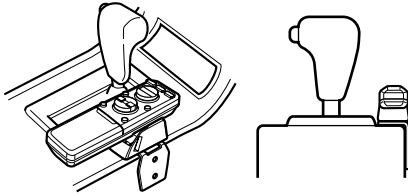

Fig. 18

Method B

This example is for when the console is not wide enough to have installation space for the mounting base.

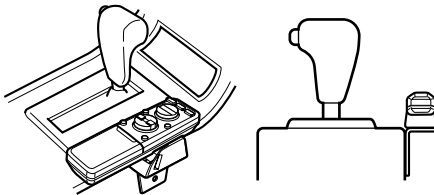

Fig. 19

Note:

- Install the mounting base in such a way that it will not hit the seat when the seat is adjusted.

1. Install the bracket to the mounting base.

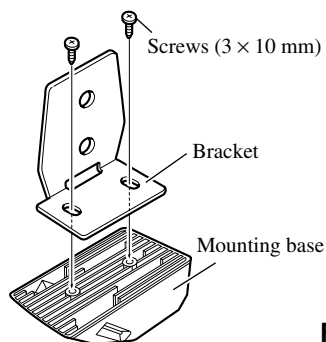

Fig. 20

2. Install the mounting base to the vehicle.

Fig. 1: Installation with double-sided tape.

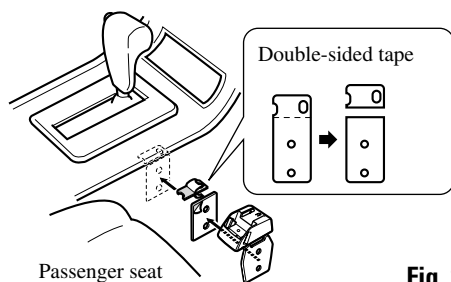

Fig. 21

Fig. 2: Installation with the screws.

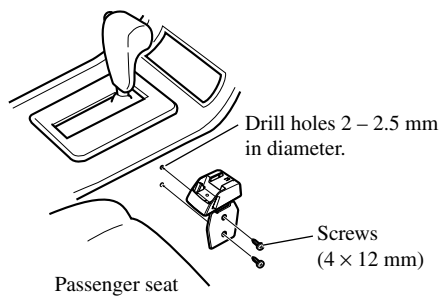

Fig. 22

General

Power source 14.4 V DC (10.8 – 15.1 V allowable)
Grounding system Negative type
Max. current consumption 4.0 A
Dimensions	
(mounting size) 178 (W) × 50 (H) × 160 (D) mm
(front face) 188 (W) × 58 (H) × 20 (D) mm
Weight 1.6 kg
Maximum preout output level 4.0 V
Digital input Optical input
Sampling frequency 44.1 – 96 kHz
Digital output Optical output

CD player

System Compact disc audio system
Usable discs Compact disc
Signal format Sampling frequency: 44.1 kHz Number of quantization bits: 16; linear
Frequency characteristics 5 – 20,000 Hz (± 1 dB)
Signal-to-noise ratio 107 dB (1 kHz) (IEC-A network)
Dynamic range 98 dB (1 kHz)
Number of channel 2 (stereo)

FM tuner

Frequency range 87.5 – 108 MHz
Usable sensitivity 9 dBf (0.8 μ V/75 Ω , mono, S/N: 30 dB)
50 dB quieting sensitivity 15 dBf (1.5 μ V/75 Ω , mono)
Signal-to-noise ratio 70 dB (IEC-A network)
Distortion 0.3% (at 65 dBf, 1 kHz, stereo)
Frequency response 30 – 15,000 Hz (± 3 dB)
Stereo separation 40 dB (at 65 dBf, 1 kHz)

MW tuner

Frequency range 531 – 1,602 kHz (9 kHz)
Usable sensitivity 18 μ V (S/N: 20 dB)
Selectivity 50 dB (± 9 kHz)

LW tuner

Frequency range 153 – 281 kHz
Usable sensitivity 30 μ V (S/N: 20 dB)
Selectivity 50 dB (± 9 kHz)

Note:

- Specifications and the design are subject to possible modification without notice due to improvements.



PIONEER CORPORATION

4-1, MEGURO 1-CHOME, MEGURO-KU, TOKYO 153-8654, JAPAN

PIONEER ELECTRONICS (USA) INC.

P.O. Box 1540, Long Beach, California 90801-1540, U.S.A.
TEL: (800) 421-1404

PIONEER EUROPE NV

Haven 1087, Keetberglaan 1, B-9120 Melsele, Belgium
TEL: (0) 3/570.05.11

PIONEER ELECTRONICS ASIACENTRE PTE. LTD.

253 Alexandra Road, #04-01, Singapore 159936
TEL: 65-6472-1111

PIONEER ELECTRONICS AUSTRALIA PTY. LTD.

178-184 Boundary Road, Braeside, Victoria 3195, Australia
TEL: (03) 9586-6300

PIONEER ELECTRONICS OF CANADA, INC.

300 Allstate Parkway, Markham, Ontario L3R OP2, Canada
TEL: 1-877-283-5901

PIONEER ELECTRONICS DE MEXICO, S.A. de C.V.

Bld. Manuel Avila Camacho 138 10 piso
Col. Lomas de Chapultepec, Mexico, D.F. 11000
TEL: 55-9178-4270

先鋒股份有限公司

總公司: 台北市中山北路二段44號13樓

電話: (02) 2521-3588

先鋒電子(香港)有限公司

香港九龍尖沙咀海港城世界商業中心9樓901-6室

電話: (0852) 2848-6488

Published by Pioneer Corporation.
Copyright © 2004 by Pioneer Corporation.
All rights reserved.

Publication de Pioneer Corporation.
Copyright © 2004 Pioneer Corporation.
Tous droits de reproduction et de traduction
réservés.